

Strategies for Demonstration and Early Deployment of Carbon Capture and Storage:
A Technical and Economic Assessment of Capture Percentage

by
Ashleigh Nicole Hildebrand

B.S. Chemical Engineering
Oklahoma State University, 2005

M.Phil. Environmental Policy
University of Cambridge, 2006

Submitted to the Department of Chemical Engineering and
the Engineering Systems Division
in partial fulfillment of the requirements for the degrees of

Master of Science in Chemical Engineering
and
Master of Science in Technology and Policy

at the
Massachusetts Institute of Technology
June 2009

© 2009 Massachusetts Institute of Technology. All rights reserved.

Signature of author:

Department of Chemical Engineering
Technology and Policy Program, Engineering Systems Division
May 8, 2009

Certified by:

Howard J. Herzog
Principal Research Engineer, MIT Energy Initiative
Thesis Supervisor

Certified by:

Gregory J. McRae
Hoyt C. Hottel Professor of Chemical Engineering
Thesis Supervisor

Accepted by:

Dava J. Newman
Professor of Aeronautics and Astronautics and Engineering Systems
Director, Technology and Policy Program

Accepted by

William M. Deen
Carbon P. Dubbs Professor of Chemical Engineering
Graduate Officer, Department of Chemical Engineering

Strategies for Demonstration and Early Deployment of Carbon Capture and Storage:
A Technical and Economic Assessment of Capture Percentage

by

Ashleigh Nicole Hildebrand

Submitted to the Department of Chemical Engineering and the Engineering Systems Division
on May 8, 2009 in partial fulfillment of the requirements for the degrees of
Master of Science in Chemical Engineering and
Master of Science in Technology and Policy
at the Massachusetts Institute of Technology

ABSTRACT

Carbon capture and storage (CCS) is a critical technology for reducing greenhouse gas emissions from electricity production by coal-fired power plants. However, full capture (capture of nominally 90% of emissions) has significant impacts on the technology, plant performance, and project economics that represent challenges for the first movers who implement the technology. This work finds that capturing only part of the emissions (i.e., partial capture) can facilitate implementation compared to full capture. Partial capture is easier to implement technologically, resulting in lower risk. To investigate plant performance and economics as a function of capture percentage, spreadsheet models were developed for both pulverized coal (PC) and integrated gasification combined cycle (IGCC) plant technologies. Compared to full capture, partial capture can preserve efficiency, and thus ability to dispatch electricity to the grid, thereby reducing the risk of stranding and ensuring that emissions reduction will occur. For a PC plant, the cost savings associated with partial capture are significant, and a reasonable mitigation cost (\$/ton of avoided emission) is maintained. This makes partial capture for PC more implementable than full capture, and a strategy of partial capture, especially for demonstrations, will accelerate commercialization of post-combustion capture. For an IGCC, the cost savings are relatively small, and there is a mitigation cost penalty associated with partial capture. The decision between full capture and partial capture for IGCC requires a trade-off of various technological and economic priorities. Due to the cost and challenge of implementing IGCC base technology, a strategy of partial capture is unlikely to accelerate commercialization of pre-combustion capture. However, partial capture strategies will assist in maintaining a robust electricity sector compared to the alternate situation of fuel-switching from coal to natural gas. This can occur through a diversified portfolio of options for technologies and fuels, consumer protection, and reduced risk of carbon lock-in.

Thesis Supervisor: Howard J. Herzog
Principal Research Engineer, MIT Energy Initiative

Thesis Supervisor: Gregory J. McRae
Hoyt C. Hottel Professor of Chemical Engineering

ACKNOWLEDGEMENTS

I am deeply grateful to Howard Herzog for allowing me to pursue a dream of working on carbon capture and storage, always ensuring that I was on the right path, and providing invaluable guidance that has helped shape me into the professional that I am now becoming. I must also thank Greg McRae for his kind advice and indefatigable support.

I would like to gratefully acknowledge the MIT Carbon Sequestration Initiative and the National Science Foundation Graduate Research Fellowship Program for their generous support that has made this work possible.

There are countless people who have contributed to the work in this thesis through discussions, emails, and encounters at conferences. While I cannot thank each of you individually, please know that I am grateful for your time and for sharing your thoughts with me.

The individuals involved in the carbon capture and storage research group have been immeasurably valuable for their camaraderie, support, intellect, and genuine friendship. These include Holly Javedan, Gary Shu, Michael Hamilton, Yamama Raza, Sarah Bashadi, Ellie Ereira, Manya Ranjan, Weifeng Li, and last but certainly not least, Mary Gallagher. There are numerous other individuals sprinkled across the MIT campus that have made my time at MIT so enjoyable.

Without the endless support, patience, and love of my fiancé Allan, I could not have achieved so many goals while finding so much happiness. My parents deserve special recognition for their unfailing encouragement. I would like to dedicate this work to my father, the late Dr. David Hildebrand, who devoted so much time to trying to make me see the practical side of things. I've finally got it now, Dad.

TABLE OF CONTENTS

Acknowledgements.....	4
Table of Contents.....	5
List of Figures.....	7
List of Tables.....	8
List of Acronyms.....	9
1 Introduction.....	10
2 Profile of Fuels for New Baseload Electricity.....	13
2.1 Near-Term Options for Baseload Generation.....	13
2.2 Generation, Consumption, and Imports.....	14
2.3 Prices and Dispatch.....	17
2.4 Emissions.....	20
3 Pressures Facing New Coal-Fired Power Plants.....	22
3.1 Coal Rush, Coal Paralysis.....	22
3.2 Legislative Efforts.....	24
3.3 Financial Challenges.....	28
3.4 Ubiquity of Opposition.....	33
3.5 Regional and State Initiatives.....	37
3.6 Utility Initiatives.....	42
3.7 Regulatory Issues.....	42
3.8 Case Study: A Tornado of Issues in Kansas.....	47
3.9 The Prevalence of Uncertainty.....	51
4 Scenarios for the Future.....	53
4.1 Business-as-Usual.....	53
4.2 Policy Options.....	53
4.3 Policy Momentum.....	55
5 Technology Process Descriptions.....	57
5.1 Pulverized Coal Plants.....	57
5.1.1 Plant Basics.....	57
5.1.2 Post-Combustion Carbon Capture.....	59
5.2 Integrated Gasification Combined Cycle Plants.....	61
5.2.1 Plant Basics.....	61
5.2.2 Pre-Combustion Carbon Capture.....	63
6 Implementation of Post-Combustion Capture.....	65
6.1 Full-Capture CCS.....	65
6.1.1 Equipment and Integration.....	65
6.1.2 Performance.....	68
6.1.3 Economics.....	69
6.2 Prospects for Partial Capture.....	69
6.3 Considerations for Retrofits.....	70
7 Implementation of Pre-Combustion Capture.....	72
7.1 Full-Capture CCS.....	72
7.1.1 Equipment and Integration.....	72
7.1.2 Performance.....	74

7.1.3	Economics.....	75
7.2	Prospects for Partial Capture	75
7.3	Considerations for Retrofits.....	77
8	PC Performance and Economic Modeling.....	79
8.1	Evaluation Methodology.....	79
8.2	Results.....	81
9	IGCC Performance and Economic Modeling.....	92
9.1	Evaluation Methodology.....	92
9.2	Results.....	94
10	Discussion and Policy Implications.....	104
10.1	Facilitated Implementation	104
10.2	Accelerated Commercialization and Emissions Abatement.....	107
10.3	Robust Electrical Sector Maintained	108
11	Conclusions and Future Work	111
11.1	Conclusions.....	111
11.2	Future Work.....	115
	References.....	116
	Appendices.....	123

LIST OF FIGURES

Figure 2-1. 2007 U.S. Electric Power Industry Net Generation	13
Figure 2-2. Electricity Generation by Source 1990-2007	14
Figure 2-3. Natural Gas: Consumption for Electricity and Imports	15
Figure 2-4. Coal: Consumption for Electricity and Imports	16
Figure 2-5. National Average Cost of Fuel for Electric Power Industry	17
Figure 2-6. Year 2005 Dispatch Curves for the ECAR and ERCOT Regions	19
Figure 3-1. Cost and Price Indices Since 2000	29
Figure 3-2. Regional Market-Based Program Participants	39
Figure 5-1. Simplified Process Flow Diagram of Pulverized Coal Power Plant	58
Figure 5-2. Simplified Process Flow Diagram of Pulverized Coal Plant with Carbon Capture..	59
Figure 5-3. Process Diagram for Carbon Dioxide Separation Using Chemical Absorption	60
Figure 5-4. Simplified Process Flow Diagram of an IGCC Power Plant	61
Figure 5-5. Simplified Process Flow Diagram of an IGCC Power Plant with Carbon Capture..	63
Figure 8-1. Plant Output Dependency on Capture Percentage for SC PC Model	82
Figure 8-2. Plant Performance Dependency on Capture Percentage for SC PC Model	83
Figure 8-3. Capital Cost Dependency on Capture Percentage for SC PC Model.....	84
Figure 8-4. Unit Cost Dependency on Capture Percentage for SC PC Model	84
Figure 8-5. Cost of Electricity Dependency on Capture Percentage for SC PC Model	85
Figure 8-6. Dependency of Avoided and Captured Emissions Cost on Capture Percentage for SC PC Model	86
Figure 8-7. Sensitivity of Unit Cost to Maximum Capture of a Single CDR Train	87
Figure 8-8. Sensitivity of Mitigation Cost to Maximum Capture of a Single CDR Train	88
Figure 8-9. Sensitivity of Cost of Electricity to Coal Price for SC PC Model	89
Figure 8-10. Sensitivity of Cost of Mitigation to Coal Price for SC PC Model.....	90
Figure 8-11. COE Comparison of SC PC and NGCC Plants with Comparable Emissions	91
Figure 9-1. Plant Output Dependency on Capture Percentage for IGCC Model.....	95
Figure 9-2. Plant Performance Dependency on Capture Percentage for IGCC Model	96
Figure 9-3. Capital Cost Dependency on Capture Percentage for IGCC Model	97
Figure 9-4. Unit Cost Dependency on Capture Percentage for IGCC Model	98
Figure 9-5. Cost of Electricity Dependency on Capture Percentage for IGCC Model.....	99
Figure 9-6. Dependency of Avoided and Captured Emissions Cost on Capture Percentage for IGCC Model.....	100
Figure 9-7. Sensitivity of Cost of Electricity to Coal Price for IGCC Model	101
Figure 9-8. Sensitivity of Cost of Mitigation to Coal Price for IGCC Model	101
Figure 9-9. COE Comparison of IGCC and NGCC Plants with Comparable Emissions.....	102

LIST OF TABLES

Table 3-1. Regional Market-Based Programs.....	38
Table 6-1. Equipment and Integration Impacts of Full Capture at a PC Plant	65
Table 6-2. Benefits of Partial Capture vs. Full Capture for Pulverized Coal Plants.....	69
Table 7-1. Equipment and Integration Impacts of Full Capture at an IGCC Plant.....	72
Table 7-2. Benefits of Partial Capture vs. Full Capture for IGCC Plants.....	77
Table 10-1. Comparison of Costs at 0%, 45%, and 90% Capture for an SC PC Plant.....	105
Table 10-2. Comparison of Costs at 0%, 45%, and 90% Capture for an IGCC Plant.....	106
Table 10-3. Summarized Benefits of Partial Capture for PC and IGCC Plants	106

LIST OF ACRONYMS

AGR	Acid gas removal unit
ASU	Air separation unit
CCS	Carbon capture and storage
CDR	Carbon dioxide removal unit
CO	Carbon monoxide
CO ₂	Carbon dioxide
COE	Cost of electricity
COS	Carbonyl sulfide
DOE	U.S. Department of Energy
EIA	Energy Information Administration
EOR	Enhanced oil recovery
EPA	U.S. Environmental Protection Agency
ESP	Electrostatic precipitator
FGD	Flue gas desulfurizer
H ₂	Hydrogen
H ₂ S	Hydrogen sulfide
HHV	Higher heating value
HRSG	Heat recovery steam generator
IGCC	Integrated gasification combined cycle
IP	Intermediate pressure
kW	Kilowatt
kWh	Kilowatt-hour
LP	Low pressure
MEA	monoethanolamine
MMBtu	Million British thermal units
MPa	Megapascal
MW	Megawatt
MWh	Megawatt-hour
NETL	National Energy Technology Laboratory
NGCC	Natural gas combined cycle
NO _x	Nitrogen oxide
O&M	Operating and maintenance
PC	Pulverized coal
ppmv	Parts per million by volume
SC	Supercritical
SCR	Selective catalytic reducer
SO ₂	Sulfur dioxide
SubC	Subcritical
T&S	Transportation and storage
TPC	Total Plant Cost
USC	Ultra-supercritical

1 INTRODUCTION

Carbon capture and storage (CCS) is a technology with important potential for reducing global emissions of carbon dioxide, a predominant greenhouse gas. When added to a coal-fired power plant, this technology can separate nearly all of the carbon dioxide resulting from combustion of coal, which can then be transported to a site for safe storage, such as an underground saline aquifer, or used for enhanced oil recovery (EOR). This prevents the gas from entering the atmosphere, where it would contribute to climate change. The long-term goal of CCS is widespread deployment of full capture, meaning that nominally 90% of emissions would be captured at each plant. This will minimize the impact of the necessary use of fossil fuels during the transition to a low-carbon energy system.

The predominant and most developed methods of achieving carbon capture include post-combustion capture, pre-combustion capture, and oxy-combustion. Post-combustion capture is applied to a traditional pulverized coal (PC) plant. Pre-combustion capture is used in conjunction with the more advanced technology of an integrated gasification combined cycle (IGCC) plant. Both of these methods can achieve nominally 90% capture of emissions. Oxy-combustion (also called oxy-firing or oxy-fuel) refers to a power plant that burns coal in nearly pure oxygen, such that the resulting emissions are primarily carbon dioxide. This allows capture of greater than 90% of emissions. There are also a variety of new methods of carbon capture that are still in the early research stages. CCS can be applied to natural gas plants, but the lower partial pressure of carbon dioxide in the flue gas of natural gas plants makes capture from natural gas much less economic than from coal on a dollar per ton of carbon dioxide basis. As such, it is not likely to be implemented at natural gas plants in the United States until it has been extensively used by coal plants.

Carbon capture and storage is on the verge of implementation. Multiple projects are currently being planned to demonstrate the technologies at scale. Even with government support, however, individual companies are having difficulty assuming the technological and economic realities of CCS. There is significant cost and risk associated with such an investment for these first movers. Yet, such demonstrations and “first of a kind” implementation provides the learning and cost

reductions necessary for widespread deployment. The longer it takes for the first movers to take action, the greater the delay will be in wide-scale implementation of CCS and emissions abatement. There is currently no apparent resolution to this stalemate.

As a potential solution, this study is aimed at understanding if partial capture (capture of less than 90% of emissions) represents a practical option for demonstrations and first movers. The objective of this strategy would be to:

- *Facilitate implementation of CCS technology.* The paradigm of full capture for CCS currently results in technological and economic challenges that deter implementation by first movers. Partial capture could reduce these challenges.
- *Accelerate the commercialization of CCS technology and abatement of carbon dioxide emissions.* If implementation can be facilitated, partial capture could get CCS technology into the marketplace more quickly, reducing emissions sooner, and expediting widespread deployment of full-capture systems.
- *Maintain a robust electrical sector.* This requires a diverse portfolio of fuel and technology options. It is also important to minimize the risk of “locking in” emissions from new plants by ensuring that they can be realistically retrofitted to reduce their emissions.

To assess such a strategy, partial capture is evaluated through assessment and modeling of post- and pre-combustion, as these technologies are amenable to capture rates less than 90%. The range of capture that would reduce emissions from coal to the level of emissions from natural gas (“natural gas parity”) is of particular importance because it would put these fuels on a level playing field and maintain a diversified fuel portfolio while still achieving substantial abatement of carbon dioxide emissions.

Baseload electricity generation and the use of coal and natural gas for electricity, including such issues as prices and electrical dispatch, are discussed in Chapter 2. Chapter 3 is a study on the recent pressures and difficulties experienced when trying to build new coal-fired power plants. Chapter 4 considers the “business-as-usual” case, in which coal plants continue to be hindered, and the idea of natural gas parity for coal as a feasible path forward. Chapter 5 describes the

technologies used for pulverized coal (PC) plants and integrated gasification combined cycle (IGCC) plants, including the processes added for capture of carbon dioxide emissions. Chapters 6 and 7 detail how CCS is practically implemented for PC and IGCC plants, respectively, including the performance and economic impacts. These chapters also discuss the prospects for partial capture with these technologies and considerations for retrofitting carbon capture onto an existing plant. Spreadsheet models were developed, based on the National Energy Technology Laboratory's "Cost and Performance Baseline for Fossil Energy Plants," to explore the plant performance and economic results as a function of capture percentage. Chapters 8 and 9 discuss these models, methodology, and the results for PC and IGCC plants, respectively. Chapter 10 provides an analysis and policy implications. Chapter 11 presents conclusions and avenues for future work.

2 PROFILE OF FUELS FOR NEW BASELOAD ELECTRICITY

2.1 NEAR-TERM OPTIONS FOR BASELOAD GENERATION

There are multiple options for the generation of electricity in the United States, including fossil fuels, nuclear, and renewable energy such as wind, solar, or hydroelectric. These resources and their contributions to electricity production are displayed below.

Figure 2-1. 2007 U.S. Electric Power Industry Net Generation¹

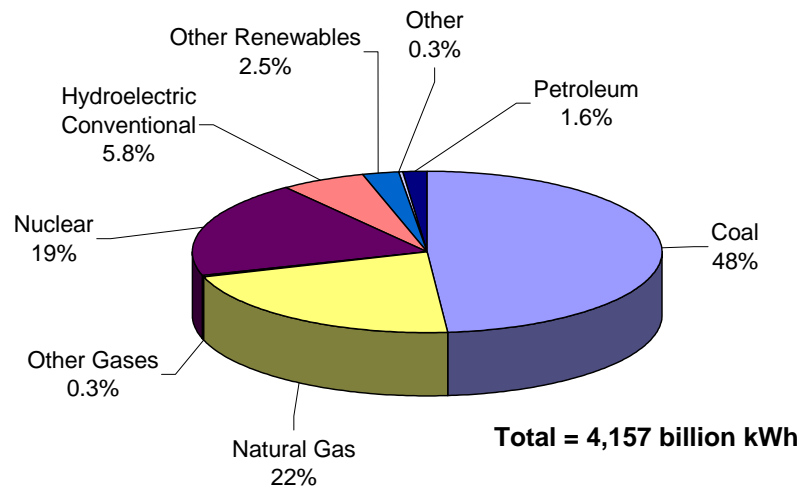

However, not all resources are suitable for baseload electricity generation, or electricity that is economically generated nearly all the time. Currently, renewables such as wind and solar are too intermittent to provide baseload electricity and expansion of their share in the market is hindered by transmission and infrastructure issues. While hydroelectric facilities do provide baseload power, suitable resources are already being fully utilized. Nuclear plants provide baseload electricity, but the future of nuclear energy is plagued by various technological, economic, and social issues. This leaves natural gas and coal as the two resources that could play substantial roles in near-term addition of electrical generating capacity.

¹ "Electric Power Annual with data for 2007." (2009) Energy Information Administration. January 21, 2009.

2.2 GENERATION, CONSUMPTION, AND IMPORTS

These two fuels have long been a resource for baseload generating capacity, although they have been utilized to various extents at different times. The figure below shows electricity generation from coal and natural gas from 1990 to 2007.

Figure 2-2. Electricity Generation by Source 1990-2007²

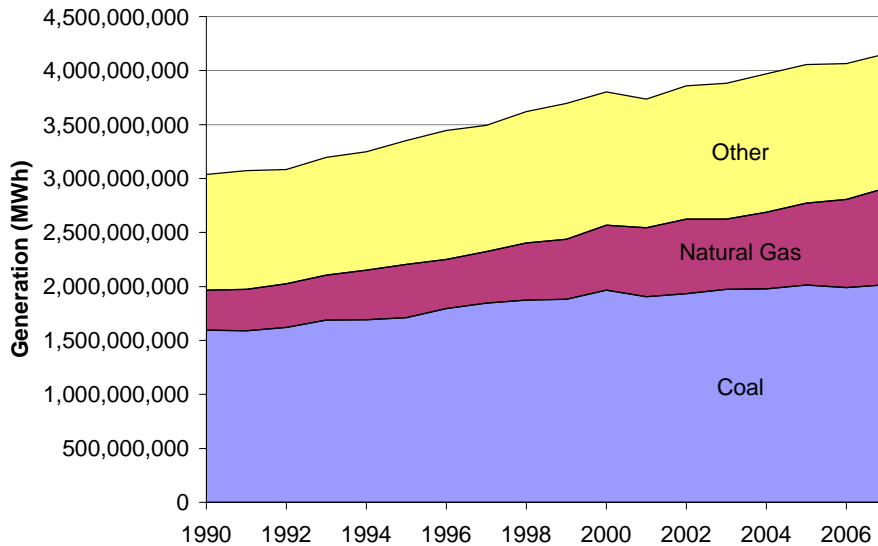

This shows that generation from natural gas has increased more than generation from coal, especially since 2003. This leads to natural gas assuming an increasing share of the resource mix.

There is important insight to be gained by considering quantities of these fuels used for electricity generation and imported into the United States. While not all of the imported fuels are used for electricity generation, the historical relationship between imports and consumption for generation is informative for predicting future relationships. The figure below displays this historical relationship for natural gas.

² Data from Ibid.

Figure 2-3. Natural Gas: Consumption for Electricity and Imports³

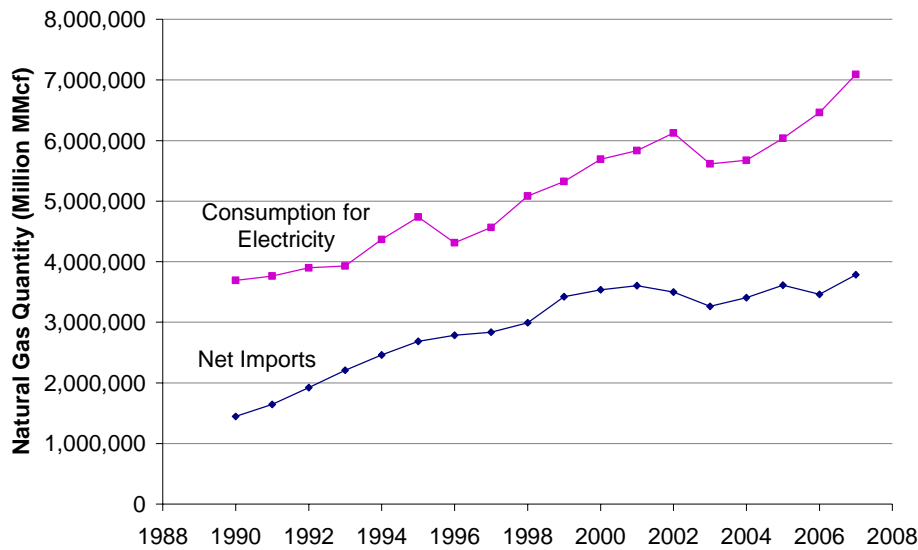

The United States is a net importer of natural gas. Gross imports were not graphed because they almost perfectly overlie the net imports; that is, exports are insignificant. In 2007, the countries from which the United States imported natural gas include, in order of decreasing quantity, Canada, Trinidad, Egypt, Nigeria, Algeria, Mexico, Qatar, and Equatorial Guinea.⁴ This figure demonstrates that, while a portion of natural gas consumption for electricity is provided by domestic resources, there does appear to be a positive correlation between imports and consumption for electricity. This gives cause to expect that as consumption of natural gas for electricity increases, more natural gas may be imported from foreign sources. There is the possibility that new resources, such as shale gas, will increase domestic supplies of natural gas, but these resources have not yet been fully vetted and the extent of their potential contribution is unknown. However, they could have an uncertain impact on this relationship between natural gas imports and consumption.

The figure below shows both net and gross imports and consumption for electricity for coal.

³ Data from U.S. Natural Gas Imports and Exports. (2008) Energy Information Administration. December 24, 2008.; "Electric Power Annual with data for 2007."

⁴ "U.S. Natural Gas Imports by Country." (2009) Energy Information Administration. Retrieved February 26, 2009.

Figure 2-4. Coal: Consumption for Electricity and Imports⁵

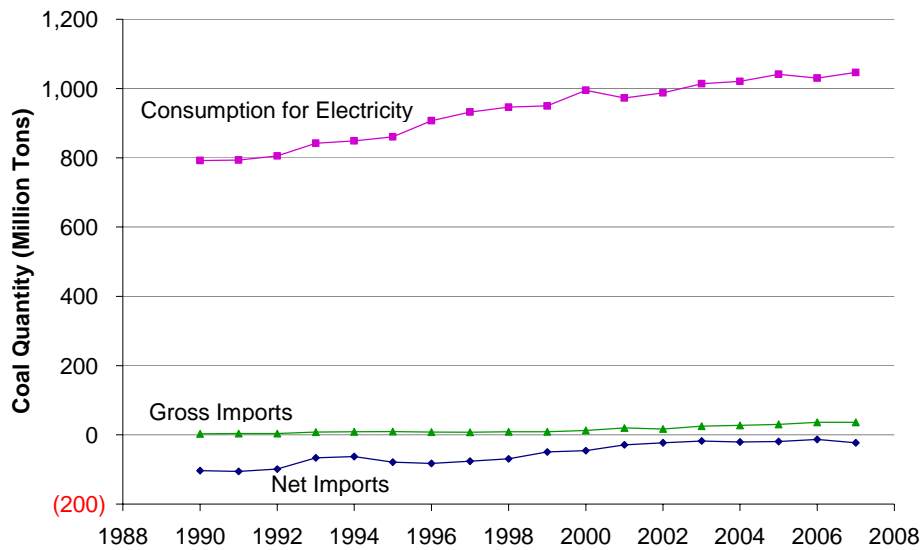

As the figure above shows, the United States is actually a net exporter of coal. In 2007, the United States exported over 42 million short tons of coal to more than 35 countries.⁶ About 27.7 million tons of coal were imported in 2007, primarily from Columbia, Indonesia, Venezuela, Canada, Russia, Bahamas, Australia, Ukraine, China, and Norway.⁷ Gross imports have stayed relatively constant compared to net imports.

Consumption of coal for electricity generation has increased steadily, but this is not strongly reflected in either gross or net imports. In fact, the import and export numbers are small compared to the quantity of coal burned for electricity. This indicates that consumption of coal for electricity probably does not have a strong impact on the United States' coal trading. In other words, the United States' domestic supply of coal is sufficiently large that foreseeable differences in electricity generation from coal are unlikely to have a direct effect on energy security.

⁵ Data from "Annual Energy Review." (2008) Energy Information Administration. June 23, 2008.; "Electric Power Annual with data for 2007."

⁶ "U.S. Coal Exports." (2008) Energy Information Administration. Retrieved February 26, 2009.

⁷ "U.S. Coal Imports." (2008) Energy Information Administration. Retrieved February 26, 2009.

2.3 PRICES AND DISPATCH

The price of these fuels is an important determinant of the price of electricity from a power plant. The figure below shows the average cost of coal and natural gas for electricity production.

Figure 2-5. National Average Cost of Fuel for Electric Power Industry⁸

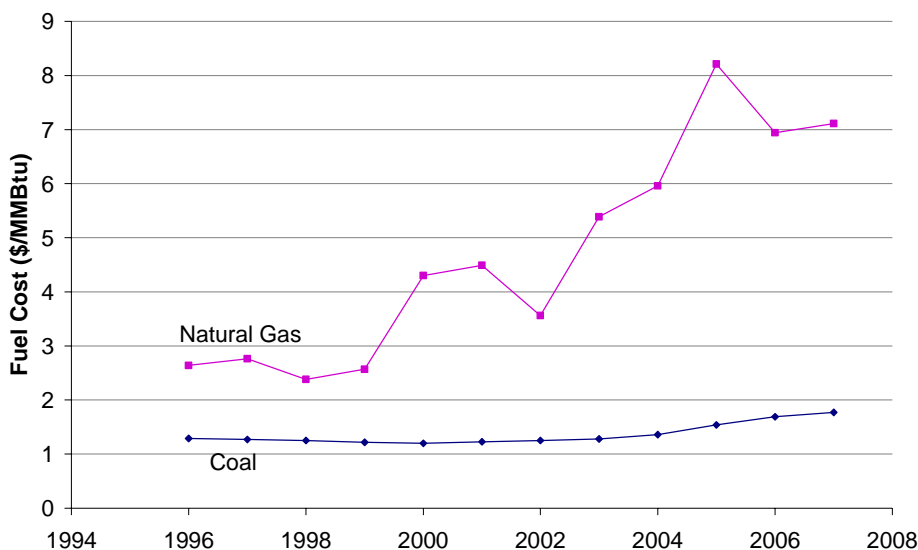

Figure 2-5 illustrates that natural gas tends to have higher and more volatile prices. Coal prices, by comparison, are low and do not exhibit volatility. The copious domestic supply of coal provides a cushion against demand-related price impacts, whereas variations in the supply and imports of natural gas lead to instability in the price of natural gas. These prices also vary by season and location, so cost of fuel for individual generators may be different. For example, in New England, the average cost of natural gas was \$12.05/MMBtu in December of 2007⁹, and the average cost of coal in December 2008 was \$3.65/MMBtu.¹⁰ These are considerably higher than the national averages. In 2007, the monthly average price paid by any utility for natural gas

⁸ Data from "Electric Power Annual with data for 2007."

⁹ "Average Cost of Natural Gas Delivered for Electricity Generation by State, Electric Power Monthly with data for December 2008." (2009) Energy Information Administration. Retrieved April 1, 2009, from http://www.eia.doe.gov/cneaf/electricity/epm/table4_13_a.html.

¹⁰ "Average Cost of Coal Delivered for Electricity Generation by State, Electric Power Monthly with data for December 2008." (2009) Energy Information Administration. Retrieved April 1, 2009, from http://www.eia.doe.gov/cneaf/electricity/epm/table4_10_a.html.

ranged from \$27.27/MMBtu to \$1.26/MMBtu, while the price for subbituminous coal ranged from \$5.58/MMBtu to \$0.379/MMBtu.¹¹ This highlights the volatility and high price tendencies of natural gas compared to coal, as well as the dependency of price on location.

These price differences also lead to differences in the utilization of coal and natural gas plants. Due to the interconnected nature of the electric grid, plants are instructed when to produce electricity. Plants are selected to dispatch electricity roughly in order of their marginal cost to produce electricity. This represents the price the plant must receive for its electricity for it to be economical to operate. Their marginal cost is largely determined by fuel cost and efficiency. The figure below shows dispatch curves from the East Central Area Reliability (ECAR) and Electrical Reliability Council of Texas (ERCOT) regions.

¹¹ Form FERC-423 Database, Monthly Cost and Quality of Fuels for Electric Plants Data. (2007) Energy Information Administration. April 1, 2009.

Figure 2-6. Year 2005 Dispatch Curves for the ECAR and ERCOT Regions¹²

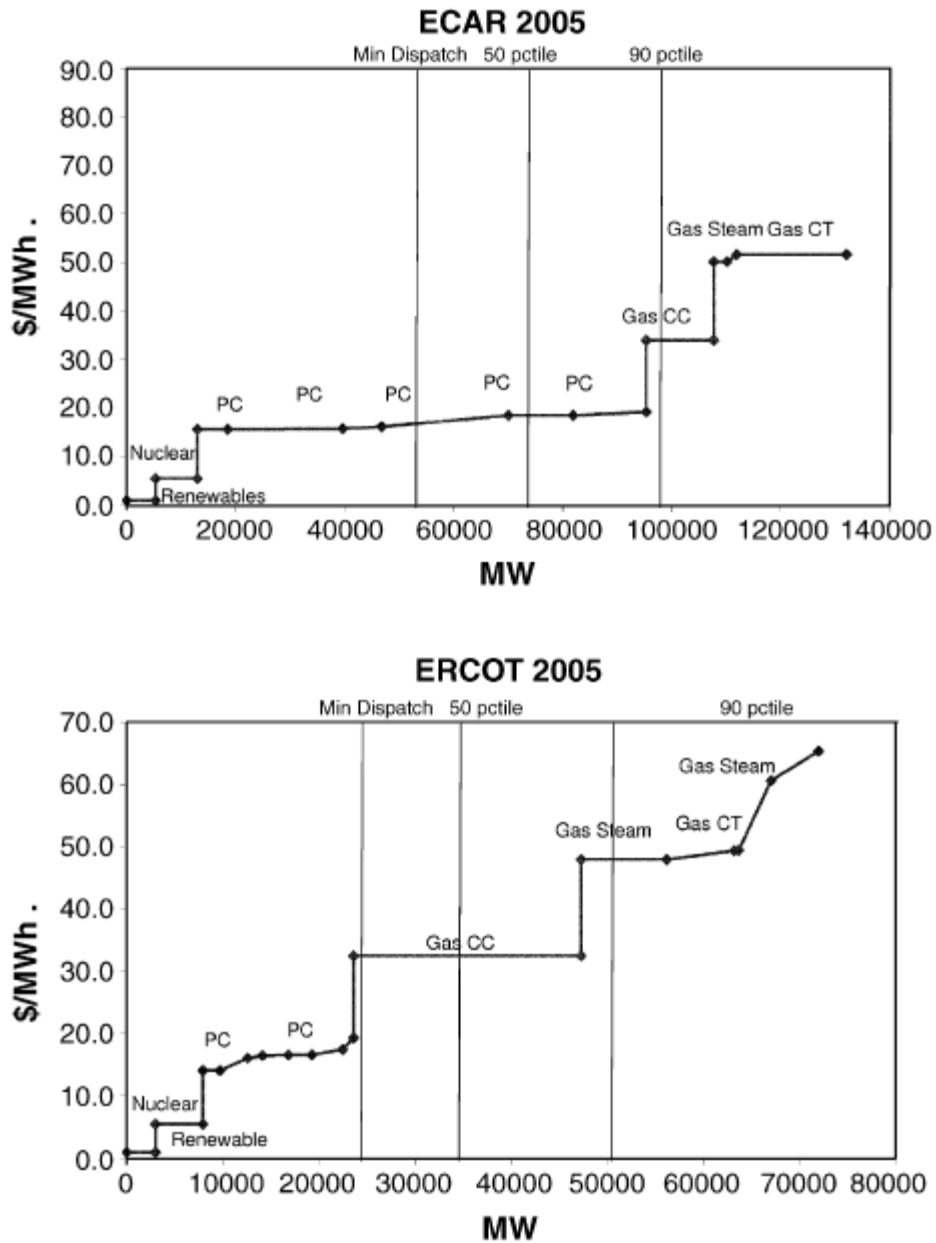

Each point on these curves represents a power plant. The marginal costs for similar types of plants are comparable, so the types of plants tend to be grouped together on the dispatch curve. Enough plants are instructed to turn on, from left to right, to satisfy the electrical demand at a

¹² Wise, Marshall A., James J. Dooley, et al. (2007) "Modelling the impacts of climate policy on the deployment of carbon dioxide capture and geologic storage across electric power regions in the United States." International Journal of Greenhouse Gas Control 1(2): 261-270.

given time. This means that renewables and nuclear plants will be chosen to dispatch first, due to their very low marginal costs. Pulverized coal plants turn on next, as the low cost of coal, combined with moderate efficiency, lead to low marginal costs. The various types of natural gas plants turn on next in order of their marginal costs. Although some natural gas plants, such as combined cycle plants, achieve high efficiency, the high fuel cost leads to high marginal costs for natural gas plants. This leads to natural gas plants often being “peaker” plants that only generate electricity when demand is high, with simple cycle natural gas plants being the last to turn on. The high marginal cost associated with natural gas also corresponds to a higher consumer electricity price. This figure also highlights the regional differences in the mix of plants and how a similar plant may get dispatched differently in different regions.

2.4 EMISSIONS

In the context of climate change, the important distinction between coal and natural gas is with respect to their emissions of carbon dioxide. The carbon content of coal, which is dependent on type and source location, is greater than that of natural gas, so it produces more carbon dioxide when combusted. For electricity generation, the important statistic is the emissions per unit of electricity, or lbs CO₂/MWh. This value will be determined by, among other things, the carbon content of the fuel and the efficiency of the power plant. As such, there is variation in the emissions profiles of a single type of plant; not all PC plants or natural gas plants exhibit the same emissions rates. Indeed, even the emissions factors used to calculate emissions are subject to uncertainty.¹³

According to major reports, carbon dioxide emissions rates from coal-fired power plants may range from 1627 – 2205 lbs/MWh, and emissions rates from natural gas combined cycle power plants may range from 791 – 843 lbs/MWh.¹⁴ Single cycle natural gas power plants have higher emissions rates than combined cycle plants due to their lower efficiency. In 1999, all emissions

¹³ "2006 IPCC Guidelines for National Greenhouse Gas Inventories." (2006) Intergovernmental Panel on Climate Change, IPCC National Greenhouse Gas Inventories Programme.

¹⁴ "IPCC Special Report on Carbon Dioxide Capture and Storage." (2005) Intergovernmental Panel on Climate Change, Working Group III. , "The Future of Coal." (2007) Massachusetts Institute of Technology. , "Assumptions to the Annual Energy Outlook 2008." (2008) Energy Information Administration. June 2008.

from natural gas electricity production averaged 1321 lbs/MWh, while those from coal averaged 2095 lbs/MWh.¹⁵ For power plants that can feasibly be built in the near term for baseload electricity, emissions from natural gas are approximately 40-65% lower than emissions from coal.

¹⁵ "Carbon Dioxide Emissions from the Generation of Electric Power in the United States." (2000)

3 PRESSURES FACING NEW COAL-FIRED POWER PLANTS

Given the energy independence and economic advantages of coal, it is important to consider the status of current efforts to use coal for baseload electricity generation. The past few years have seen increasing difficulty in siting, permitting, and building coal-fired power plants. Progressively more of these difficulties are related to concerns about climate change and coal-fired power plants' contribution to the atmospheric concentration of carbon dioxide. This has contributed to large numbers of plans and proposals for new plants being cancelled or postponed. The issue has affected both pulverized coal (PC) plants and integrated gasification combined cycle (IGCC) plants. The impediments to new plants include financial difficulties, impending yet uncertain federal climate change action, state and regional policies and initiatives, organized social opposition, and legal and regulatory challenges.

3.1 COAL RUSH, COAL PARALYSIS

From the mid-1980s until 2000, announcements of new coal-fired power plants practically ceased while low natural gas prices led to the preferential building of natural gas power plants to satisfy demands for new electrical capacity.¹⁶ However, 2000 ushered in escalating natural gas prices¹⁷, and there was a “coal rush” – a dramatic resurgence of plans for new coal plants.

The U.S. Department of Energy's National Energy Technology Laboratory (NETL) began tracking plans and proposals for new plants in 2000. Projects on the list include “progressing” projects that are near or under construction, or have received their permits, as well as “announced” projects that are in preliminary development, perhaps including a feasibility study.¹⁸ By the summer of 2008, the coal rush had amounted to the proposal of over 200 projects

¹⁶ Nace, Ted (2008) "Trends in Coal Plants." Personal Communication. July 8, 2008.

¹⁷ "Annual United States Natural Gas Industrial Price." (2008) U.S. Energy Information Administration. Retrieved August 26, 2008, from <http://tonto.eia.doe.gov/dnav/ng/hist/n3035us3A.htm>.

¹⁸ Shuster, Erik (2008) "Tracking New Coal-Fired Power Plants." National Energy Technology Laboratory. June 30, 2008.

in 42 states.¹⁹ Twenty-two plants became operational between 2000 and June 2008²⁰, and in August 2008, approximately 30 power plants were under construction around the country.²¹ As of November 2008, there were as many as 100 projects in various stages of development around the country.²²

For the reasons discussed below, it is becoming harder than ever to execute the building of new plants, resulting in a kind of “coal paralysis.” During 2007 a total of 59 proposals were cancelled, postponed, or put on hold.²³ Sixteen plants saw the same fate in 2008.²⁴

It is important to note that it is typical for only a portion of proposed plants to be completed, as pointed out in the June 30, 2008 update of NETL’s *Tracking New Coal-Fired Power Plants*: “Historically, actual capacity has been seen to be significantly less than proposed capacity. For example, the 2002 report listed 36,161 MW of proposed capacity by the year 2007 when actually only 4,478 MW (12%) were constructed.”²⁵ Similarly, from 2005 to mid-2008, an average of 800 MW was added per year, representing only 11% of the “progressing” capacity intended to be online by 2011.²⁶ Indeed, it is not unusual for plants in the preliminary “announced” stage to be cancelled, as they may only be exploratory and not representative of a strong financial commitment.²⁷ While such slow progress may be typical, the Energy Information Administration had projected that the United States would need an additional 6000 MW per year

¹⁹ "Articles on Coal." (2008) SourceWatch, CoalSwarm. Retrieved August 26, 2008, from http://www.sourcewatch.org/index.php?title=Articles_on_coal.

²⁰ Shuster

²¹ Davidson, Paul (2008) "Coal king Peabody cleans up." USA Today. August 8, 2008.

²² Weiss, Mitch (2008) "Environmentalists try to stop NC coal-fired plant." Forbes.com. November 18, 2008.

²³ "Coal plants cancelled in 2007." (2008) SourceWatch, CoalSwarm. Retrieved August 26, 2008, from http://www.sourcewatch.org/index.php?title=Coal_plants_cancelled_in_2007.

²⁴ "Coal plants cancelled in 2008." (2008) SourceWatch, CoalSwarm. Retrieved January 19, 2009, from http://www.sourcewatch.org/index.php?title=Coal_plants_cancelled_in_2008.

²⁵ Shuster

²⁶ Ibid.

²⁷ Ibid.

through 2030 to keep up with demand²⁸, or 7.5x the current rate. Although this number is likely to drop due to recent economic circumstances, the recent prevalence of cancellations adds to concerns about whether future demand will be met.

Reviewing the causes of plant cancellations and postponements reveals important themes. Many of the cancellations in recent years can be attributed to two relatively new trends: escalating costs and concerns about climate change. Escalating capital costs have resulted in impractical costs for new plants, and concerns about climate change have contributed to financing difficulties, impending federal action, state and regional initiatives, public pressure, and legal and regulatory challenges. Of the 59 plant cancellations that occurred in 2007, 15 were strongly influenced by climate change issues²⁹, as were three of the 18 plants cancelled in 2008.³⁰ Many others were influenced by circumstances relating to climate change concerns, even if not directly. As each of the factors contributing to this coal paralysis is discussed, highlights of relevant plant cancellations are concurrently presented.

3.2 LEGISLATIVE EFFORTS

It has become apparent that something must be done nationally to curb greenhouse gas emissions, and multiple pieces of enacted and proposed federal legislation have addressed the issue. Passed and proposed legislation includes provision of funds or incentives for carbon capture and storage (CCS) research, development, and deployment, establishment of a nationwide cap-and-trade system, and a moratorium on all non-capture coal-fired power plants. Uncertainty regarding what legislation will be passed has contributed to coal paralysis as utilities cannot make adequately informed business decisions that depend on the details of future legislation.

A relevant piece of legislation that was passed is the “Energy Independence and Security Act of 2007,” which was signed into law in December of that year.³¹ It includes a provision for \$240M

²⁸ "Tracking New Coal-Fired Power Plants." (2007) National Energy Technology Center. May 1, 2007.

²⁹ "Coal plants cancelled in 2007."

³⁰ "Coal plants cancelled in 2008."

³¹ "Fact Sheet: Energy Independence and Security Act of 2007." (2007) The White House, Office of the Press Secretary. December 19, 2007.

per year from 2008-2012 for fundamental CCS research, \$200M per year from 2009-2013 for large-scale CCS projects, and smaller sums for CCS-related research.³² More recently, the “American Recovery and Reinvestment Act of 2009” has included \$3.4B provisions for CCS. This includes \$1B for research programs, \$800M for the government’s Clean Coal Power Initiative for demonstration projects, \$1.52B for industrial CCS demonstrations, \$50M for characterization of storage sites, and \$20M for training and research grants for geologic sequestration.³³

One increasingly popular scheme for financing CCS projects is the idea of establishing a CCS trust fund, paid for by a small fee leveraged on all fossil fuel-based electric generation. In pursuit of this idea, Representative Boucher introduced a bill, the “Carbon Capture and Storage Early Deployment Act,” that would accumulate \$1B per year and distribute the funds through grants and contracts with the goal of accelerating the development and commercialization of a variety of CCS technologies.³⁴

Multiple pieces of legislation have sought to establish a nationwide cap-and-trade system for greenhouse gas emissions. Trading systems effectively force the included sectors to pay for the right to emit carbon dioxide or abate their emissions. The price on these rights to emit, or carbon credits or allowances, is determined by the market and can be traded among participants. This mechanism is design to ensure that emissions are reduced most efficiently because those with the lowest abatement cost will reduce their emissions and sell their credits to those with higher abatement cost. The effectiveness of such a system on reducing emissions is dependent on how many allowances are available, or the cap, determined by the emission reduction goal. If the number of credits is below the aggregated level of emissions, overall reductions in emissions will result, and the price to emit will be non-negligible. Systems are usually designed with a cap that

³² Energy Independence and Security Act of 2007. (2007) H.R. 6, United States House of Representatives. Version December 19, 2007.

³³ "Fact Sheet: American Recovery and Reinvestment Act (Economic Stimulus Package)." (2009) American Public Power Association. February 2009.

³⁴ Carbon Capture and Storage Early Deployment Act. (2008) H.R. 6258, United States House of Representatives. Version June 12, 2008.

will decline over subsequent years, leading to escalating emission reductions. For power plants, some may install CCS, and others will buy permits, resulting in higher costs in both cases. These higher costs can be difficult to recoup. To facilitate investment in CCS, then, the legislation also includes incentives for CCS research, development, and deployment.

A recent prominent cap-and-trade bill is “America’s Climate Security Act of 2007” (often referred to as Lieberman-Warner). The overall emissions reduction goal is 70% below 2005 emissions levels by 2050, with interim caps. It incentivizes CCS by providing bonus allowances for CCS projects, contingent upon meeting a certain level of emissions, which will decline over time. Power projects that achieve 85% capture and an emissions level at or below 250 lbs CO₂ per MWh are also eligible for either loan guarantees, cost sharing for incremental costs of CCS, or production payments.³⁵ The “Low Carbon Economy Act of 2007” (referred to as Bingaman-Specter) specifies a reduction to 1990 emission levels by 2030. Similar to the Lieberman-Warner bill, it also includes provision of bonus allowances for CCS activities and a choice of loan guarantees, cost sharing, or production payments for qualifying CCS projects.³⁶ The Lieberman-Warner bill was addressed on the Senate floor in June 2008 but, as expected, did not receive enough votes for full consideration.³⁷ Regardless of its defeat, the fact that it was debated on the Senate floor represents progress and potentially facilitates a serious discussion of similar bills.

Most recently, on March 31, 2009 Representatives Waxman and Markey released a discussion draft of new cap-and-trade legislation entitled “American Clean Energy and Security Act of 2009.” It calls for reduction of emissions of seven greenhouse gases to 83% below 2005 levels by 2050, with interim goals for 2012 and 2020. Federal agencies would be required to develop a strategy for deployment of CCS, including relevant legal and regulatory issues for sequestration and transportation. The legislation would establish the Carbon Storage Research Corporation, to be managed by the Electric Power Research Institute. The Corporation would assess and

³⁵ Climate Security Act of 2007. (2007) S. 2191, United States Senate. Version October 18, 2007.

³⁶ Low Carbon Economy Act of 2007. (2007) S. 1766, United States Senate. Version July 11, 2007.

³⁷ Herszenhorn, David M. (2008) "After Verbal Fire, Senate Effectively Kills Climate Change Bill." The New York Times. June 7, 2008.

implement a strategy for accelerated deployment of CCS technologies. In pursuit of the trust fund concept, it would collect a small fee from fossil fuel-based electricity generators, to be used for funding and coordinating a carbon capture and sequestration demonstration and early deployment program. For commercial deployment, the EPA administrator will also provide funds, partly based on a sliding scale that will provide higher payments for projects that achieve higher capture and storage rates. It would furthermore establish emissions performance standards for the permitting of new coal-fired power plants. For plants permitted after January 1, 2015, they must emit no more than 1,100 lbs of carbon dioxide per MWh; the standard is 800 lbs per MWh after January 1, 2020. However, the plants permitted between these dates will only be required to meet this after the administrator has made determinations that CCS is being sufficiently utilized in the United States or worldwide, or in 2015, whichever comes first. These standards are to be reviewed every 5 years, and are to be lowered if it has been demonstrated that a lower emissions rate is achievable.³⁸

Moratoriums against coal-fired power plants have also been proposed, and one federal bill to that end has been introduced. Many notable public figures and organizations have called for a complete moratorium against coal-fired power plants that do not capture and store their carbon dioxide emissions. In addition to many environmental groups, NASA's James Hansen and former Vice President Al Gore are among the most vociferous proponents of a moratorium.³⁹ On April 9, 2008, the Governor of Maine signed into law a moratorium on new coal gasification plants in the state, which lasts three years or until the Board of Environmental Protection develops emissions standards for gasification plants.⁴⁰ In the federal government U.S. Representative Waxman introduced legislation titled "Moratorium on Uncontrolled Power Plants Act of 2008" which would establish a moratorium by denying permits to all coal-fired power

³⁸ American Clean Energy and Security Act. (2009) Version March 31, 2009.

³⁹ Efstathiou, Jim (2008) "Climate Laws 'Pointless' Without Coal Plant Ban, Scientist Says." Bloomberg. April 23, 1008.; Gore, Albert (2007) Nobel Lecture. Oslo, Norway. December 10, 2007.

⁴⁰ "MacDonald carbon emissions bill receives unanimous support." (2008) Boothbay Register. March 13, 2008.; "Gasification plant bill signed into law." (2008) Wiscasset Newspaper. April 17, 2008.; An Act to Minimize Carbon Dioxide Emissions from New Coal-powered Industrial and Electrical Generating Facilities in the State. (2008) LD 2126, State of Maine Legislature. Version April 2, 2008.

plants that do not achieve at least 85% capture. The moratorium would remain in place until a federal program reducing emissions to 80% below 1990 levels by 2050 is enacted.⁴¹ However, the new Secretary of Energy, Steven Chu, declared in his senate confirmation hearing that a moratorium does not make sense. “We will be building some coal plants, and one doesn’t have a hard moratorium on something like that while we search for a way to capture carbon safely.”⁴² This recognizes the inherent necessity of relying on coal while the transition to a low-carbon energy system is still under way.

While current and future legislation may have strong similarities, even the small degree of variance among them can make the difference between a plant being profitable or a loss. The frequency with which new initiatives are introduced compounds the uncertainty. Every project that is invested in becomes a huge liability in such circumstances. Especially given the long lead time of power plant planning and construction, businesses cannot risk years’-worth of resources and money into a project whose economic status will change with the signing of legislation. While climate change laws are likely to increase the cost of power plants, the choosing of legislation will provide utilities with certainty necessary to make informed business decisions.

3.3 FINANCIAL CHALLENGES

Since 2004, the capital and operating costs of new power plants have sharply escalated. The main drivers of the escalation are increasing global demand for raw materials, increased international demand for plant components and equipment, an increase in the price of coal, and increases in the cost of labor, engineering, and construction costs, partly due to contractor backlogs.⁴³ This affects all types of capital-intensive projects, including those proposing to include CCS⁴⁴ and nuclear plants.⁴⁵ Increases in demand under supply constraints result in

⁴¹ Moratorium on Uncontrolled Power Plants Act of 2008. (2008) H.R. 5575, United States House of Representatives. Version March 11, 2008.

⁴² LoBianco, Tom (2009) "Energy pick Chu backs 'clean coal.'" The Washington Times. January 14, 2009.

⁴³ Chupka, Marc W. and Gregory Basheda (2007) "Rising Utility Construction Costs: Sources and Impacts." The Brattle Group, prepared for the Edison Foundation. September 2007.

⁴⁴ Hamilton, Michael and Howard Herzog (2008) "Cost Update for The Future of Coal." Internal Report, Massachusetts Institute of Technology. August 14, 2008.

⁴⁵ Loder, Asjlyyn (2008) "Nuke plant price triples." St. Petersburg Times. March 11, 2008.

higher prices and thus increased costs for new plants. An indication of this escalation can be seen in Figure 3-1 which displays the rise in various indices since the year 2000.

Figure 3-1. Cost and Price Indices Since 2000⁴⁶

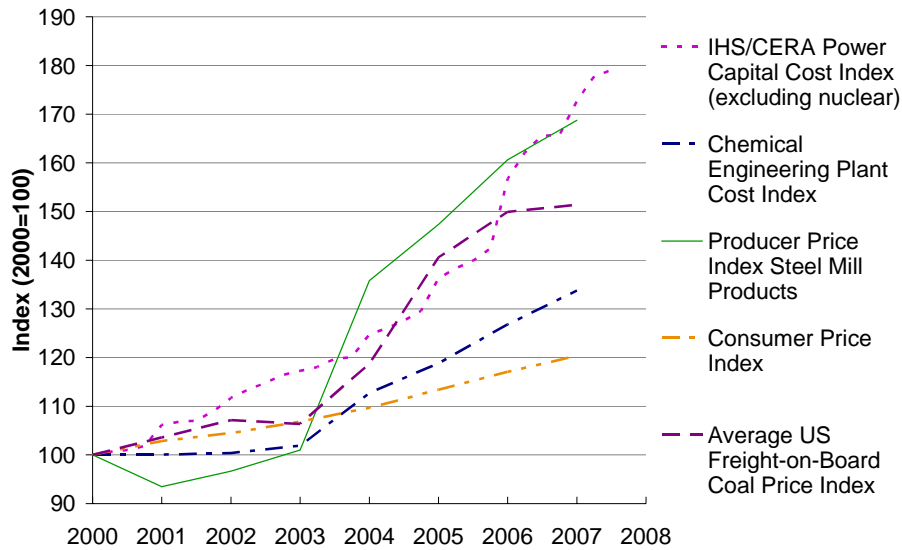

These escalating costs have resulted in multiple plant cancellations, as projected total costs can more than double during the long lead time of power plants. Rising construction costs have been cited in the cancellations of an Agrium Corp. gasification and electric plant in Alaska⁴⁷, Associated Electric Cooperative's 600 MW Norborne Baseload Plant whose cost had escalated to \$2B⁴⁸, Tondu Corp's Nueces IGCC plant in Texas⁴⁹, Xcel Energy's 600 MW IGCC plant in Colorado⁵⁰, an 850 MW Westar Energy plant in Kansas⁵¹, and a Buffalo Energy Partners IGCC

⁴⁶ Hamilton and Herzog

⁴⁷ Bradner, Tim (2008) "Agrium blames construction costs, financing environment for cancellation of coal gasification project for Kenai fertilizer plant." Alaska Journal of Commerce. March 14, 2008.

⁴⁸ "AECI suspends plans to build Norborne power plant." (2008) Associated Electric Cooperative Inc. March 3, 2008.

⁴⁹ "Stopping the Coal Rush." (2008) Sierra Club. Retrieved August 28, 2008, from <http://www.sierraclub.org/environmentallaw/coal/plantlist.asp>.

⁵⁰ Proctor, Cathy (2007) "Xcel delays IGCC power plant." Denver Business Journal. October 30, 2007.

⁵¹ Carpenter, Tim (2007) "Holcomb plant at center of emissions conflict." The Capital-Journal. September 23, 2007.

plant in Wyoming.⁵² Westar reported that the capital costs for a new plant ballooned 40% in only 18 months.⁵³ Until the drivers of these escalations subside, increasing plant costs are likely to continue hampering the building of new plants.

Even projects by the federal government are not impervious to this challenge. In 2003, the U.S. Department of Energy (DOE) announced that it would develop a 275 MW electricity and hydrogen production plant using coal gasification technology with near-zero emissions, including 90% capture and storage of carbon dioxide emissions.⁵⁴ Dubbed “FutureGen,” the project was initially expected to cost \$950M, with the cost shared between the DOE and the FutureGen Alliance, a non-profit consortium of 12 of the largest utility and coal companies.⁵⁵ By January 2008 the projected total cost had nearly doubled to \$1.8B, and the DOE announced they could no longer afford to pursue the project.⁵⁶ It is reported that around \$50M, \$40M of which was federal money, had already been spent on preliminary plans for FutureGen, including the selection of a site in Illinois.⁵⁷ The “restructured” FutureGen approach now being pursued by the DOE involves investing in multiple projects and perhaps multiple technologies, with the government only paying for the incremental costs of CCS, expecting it to be a better financial investment.⁵⁸ However, it is now apparent that the original FutureGen is also being reconsidered, so the situation may change again.

The building of a power plant represents a considerable investment, especially given the recent increase in costs. The power industry is “the most capital-intensive of any industry, responsible

⁵² Klein, Alex (2007) "TECO, Nuon Cancellations Underscore IGCC's Woes." *Emerging Energy Research*. October 5, 2007.

⁵³ Joyce, Christopher (2007) "American 'Coal Rush' Hits Some Hurdles." *National Public Radio*. January 17, 2007.

⁵⁴ "FutureGen - A Sequestration and Hydrogen Research Initiative." (2003) U.S. Department of Energy, Office of Fossil Energy. February 2003.

⁵⁵ Ling, Katherine (2008) "FutureGen showdown featured in Senate hearing." *Environment & Energy Daily*. May 5, 2008.

⁵⁶ *Ibid.*

⁵⁷ Wald, Matthew L. (2008) "Mounting Costs Slow the Push for Clean Coal." *The New York Times*. May 30, 2008.

⁵⁸ "DOE Announces Restructured FutureGen Approach to Demonstrate Carbon Capture and Storage Technology at Multiple Clean Coal Plants." (2008) U.S. Department of Energy, Office of Fossil Energy. January 30, 2008.

for \$427 billion in borrowing in 2007, according to JP Morgan.”⁵⁹ The growing risk of power projects, partly due to the uncertain impact of impending federal legislation, is also being felt by those who lend money for such projects. In response to this and pressure from environmental groups, on February 4, 2008 three major Wall Street lenders, Citigroup Inc, J.P. Morgan Chase & Co., and Morgan Stanley, issued “Carbon Principles” that “will require utilities seeking financing for plants...to prove the plants will be economically viable even under potentially stringent federal caps on carbon dioxide.”⁶⁰ In order to receive the funding, plant proposals must include analysis of energy efficiency and renewable energy options, and the suitability of the plant and site for CCS. They must additionally use conservative estimates about the number of carbon credits they would receive under a federal cap-and-trade system, and show that they could charge high enough rates to remain economic under such a system.⁶¹ The principles were developed with assistance from Environmental Defense and the Natural Resources Defense Council⁶², two groups that have pushed strong responses to climate change. Initially applicable only to investor-owned utilities, they are considering extending the principles to municipal utilities as well.⁶³ In April 2008, Bank of America announced that it was also adopting the principles for its power plant investments.⁶⁴

In a similar move in March 2008, the Department of Agriculture suspended its loan program for rural utilities, citing the uncertainties of climate change legislation and escalating construction costs. The Office of Management and Budget requested the suspension because it judged the loans too risky. In response, power providers counting on the loans may cancel projects or seek more expensive private loans.⁶⁵ The suspension of the program contributed to the halting of at least one project, the 600 MW Norborne Baseload Plant by Associated Electric Cooperative.⁶⁶

⁵⁹ Smith, Rebecca (2008) "Banks Hope to Expand Carbon Rules to Public Utilities." The Wall Street Journal. March 20, 2008.

⁶⁰ Ball, Jeffrey (2008) "Wall Street Shows Skepticism Over Coal." The Wall Street Journal. February 4, 2008.

⁶¹ Ibid.

⁶² Ibid.

⁶³ Smith

⁶⁴ Johnson, Keith (2008) "Bank of America: More Heat on Coal." The Wall Street Journal. April 2, 2008.

⁶⁵ "Loans program for coal plants suspended." (2008) AFX News Limited. March 5, 2008.

⁶⁶ "AECI suspends plans to build Norborne power plant."

These two events, adoption of Wall Street's Carbon Principles and suspension of the government's rural utility loan program, reflect investor's apprehension about financing projects where the economics rely upon conditions that are yet to be determined, such as federal legislation. While making it overall harder for coal-fired power plant projects to get financing, these steps do provide some greater certainty upon which business decisions can be made. It can be expected that such rules will lead to alternate investments in power sources other than coal, such as natural gas.⁶⁷

For a power plant to be a wise investment, it must be able to recover its costs, primarily through the rates it charges to customers. When a power plant is in a regulated electricity market, the utility or power provider must have these rates approved by a regulatory board (often called a utility commission, public service commission, or corporation commission). The purpose of the board is to ensure that electricity developments are in the public interest, meaning that there is demonstrated need for a new project and that rates charged to consumers are reasonable. In a deregulated market, electricity provision is competitive, and a utility or power provider must be able to charge rates high enough to cover costs, but not price themselves out of the market entirely. Due to the increased costs they incur, use of CCS or having to buy carbon credits increases the rate a utility must be able to charge. If they cannot charge a high enough rate due to regulators' decisions or the competitive market, the project will not be financed.

There have been multiple instances of plans and proposals for new coal-fired power plants being denied by the regulatory board because it has determined that they cannot recoup the cost of the plant or that a rate hike is not justified, sometimes because a need for the plant had not been proven. The Oregon Public Utility Commission rejected PacifiCorp's addition of a 575 MW unit to their Hunter plant in Utah because there was not demonstrated need.⁶⁸ One of two 800 MW units to be built at Duke Energy's Cliffside station was denied by the North Carolina Utilities Commission because it could not meet the burden of proof of need.⁶⁹ The Florida Public Service

⁶⁷ Johnson

⁶⁸ "Stopping the Coal Rush."

⁶⁹ Ibid.

Commission rejected the two 980 MW units planned for Florida Power and Light's Glades Power Plant due to a lack of need and uncertainties.⁷⁰ Excelsior Energy's 600 MW IGCC Mesaba project was denied by the Minnesota Public Utilities Commission, saying that it was "not in the public interest."⁷¹ Appalachian Power, whose parent company is AEP, planned a new 629 MW IGCC plant in West Virginia that would supply power to both West Virginia and Virginia.⁷² The \$2.23B plant was approved in West Virginia, but the State Corporation Commission of Virginia rejected it in April 2008, saying that the rate hike was not justifiable and that the CCS options for the plant had not been suitably addressed.⁷³ These examples show that cancellations of projects for reasons such as this are not uncommon.

3.4 UBIQUITY OF OPPOSITION

Between concerns about climate change and other environmental impacts of coal-fired power plants, there are ample grounds for individuals or groups to challenge the building of new plants. These challenges usually come in the form of formal legal challenges or social pressure such as public protests.

Formal challenges often involve lawsuits or appeals of permits granted for new plants. In January 2008, at least 48 plants were being legally challenged in 29 states.⁷⁴ The Sierra Club, a prominent environmental advocacy group, has vowed to oppose plants due to mercury and carbon dioxide emissions, compounding the impact on building of new plants.⁷⁵ In an Associated Press article, Bruce Nilles, the lawyer leading the Sierra Club's national campaign against coal, was quoted as saying, "Our goal is to oppose these projects at each and every stage, from zoning and air and water permits, to their mining permits and new coal railroads. They

⁷⁰ "Florida Public Service Commission Denies Determination of Need for Proposed Power Plants in Glades County." (2007) State of Florida. June 5, 2007.

⁷¹ "State agency blocks coal power plant." (2007) Minnesota Center for Environmental Advocacy. August 3, 2007.

⁷² Efstathiou

⁷³ "SCC says no to new APCO power plant and rate hike." (2008) WSLs. April 14, 2008.

⁷⁴ "Coal power goes on trial across U.S." (2008) MSNBC. January 14, 2008.

⁷⁵ Kosich, Dorothy (2008) "Sierra Club says it will sue to stop coal-fired power plant projects." MineWeb Newsletter. May 8, 2008.

know they don't have an answer to global warming, so they're fighting for their life."⁷⁶ Sometimes even the environmental regulators get sued. The group Environmental Defense sued the Texas Commission on Environmental Quality, saying that the standards the Commission was applying in permitting decisions for coal-fired power plants were inadequate.⁷⁷

In some cases, lawsuits result in settlements that force the reduction of carbon emissions. In a suit against Wisconsin plants that never installed mandatory pollution control technology, a settlement with the Sierra Club was reached that involved completely eliminating the use of coal at three plants in Madison.⁷⁸ A settlement was also reached with Environmental Defense and the Texas Clean Air Cities Coalition regarding the addition of a third 800 MW unit to NRG's Limestone station in Texas. They agreed to stop opposing the permit for the project in exchange for NRG's commitment to offset or sequester 50% of emissions from the unit and from any new plants they build in Texas. In addition, any new plants must be either a gasification plant or ultra-supercritical, progress must be made in reducing other hazardous emissions and water usage, and contribution towards a sequestration pilot project was mandated.⁷⁹

Plants are also experiencing strong opposition from individuals and organized social groups. For example, in response to utility TXU's much-publicized push to build eleven new coal plants in Texas, the mayor of Dallas formed the Texas Clean Air Cities Coalition, designed to give residents an active voice in the permitting decisions for such plants.⁸⁰ Between the coalition and public outrage across the country, as part of a buyout deal to private equity firms, the company agreed to reduce the plan to three new plants and various other environmental commitments, including the support of federal climate change legislation.⁸¹

⁷⁶ "Coal power goes on trial across U.S."

⁷⁷ Loftis, Randy Lee (2006) "Coming Sunday: Fight looms over Texas air pollution regulations." The Dallas Morning News. November 10, 2006.

⁷⁸ Bauer, Scott (2008) "Wis. governor says no to coal for power plants." Chicago Tribune. August 1, 2008.

⁷⁹ "NRG in pact for 800 MW coal-fired power plant." (2008) Power Engineering. August 4, 2008.

⁸⁰ Goodell, Jeff (2007) "Big Coal's Dirty Move." Rolling Stone. January 12, 2007.

⁸¹ Souder, Elizabeth (2007) "TXU to take buyout." The Dallas Morning News. February 26, 2007.

These issues are not exclusive to the United States. A debate of the same scale erupted about the building of Britain's first coal-fired power plant in 30 years. An existing plant in Kingsnorth, Kent is due to be replaced by the new plant by the company E.ON. Opinions have been strongly voiced both in favor of and against the plant, most of which revolves around the plant's expected carbon emissions. In August 2008, the organization Camp for Climate Action rallied about 600 people at the existing plant in a protest aimed at shutting down the plant. This event "joins four similar protests worldwide this year, targeting the coal industry in Australia, Germany, and North America"⁸², indicative of the level of activity against coal power plants. The decision to approve or deny the air permit for the new facility drove many people and organizations to take a stand. In a letter dated April 1, 2008, the President of the Royal Society, Lord Martin Rees, conveyed his opinion to Secretary of State John Hutton: "Allowing any new coal-fired power station, such as Kingsnorth, to go ahead without a clear strategy and incentives for the development and deployment of carbon capture and storage (CCS) technology would send the wrong message about the U.K.'s commitment to address climate change, both globally and to the energy sector."⁸³ The volume of dissent and uncertainty regarding the permit impelled E.ON to request that the ministers "delay granting planning permission until the government has decided its approach to carbon capture," essentially stalling the project.⁸⁴

These stories of serious pressure against coal plants are not uncommon. When the air permit for Duke Energy's Cliffside plant in North Carolina was granted, 20 environmental groups vowed to appeal the approval.⁸⁵ Thirteen people were arrested at a protest during an upgrade to the largest power station in the country of Wales.⁸⁶ The 1500 MW Desert Rock plant in New Mexico has experienced organized protests by environmentalists and the Navajo people, on whose land the

⁸² Wynn, Gerard and Jacqueline Cowhig (2008) "Coal's future is safe - but what about the climate?" [Reuters](#). August 5, 2008.

⁸³ Rees, Martin (2008) "Letter to Secretary of State, Department for Business, Enterprise & Regulatory Reform." Personal Communication. April 1, 2008.

⁸⁴ Adam, David (2008) "Coal power policy under attack from top scientists." [The Guardian](#). April 3, 2008.

⁸⁵ "Groups fight power plant permit." (2008) [CNN](#). March 19, 2008.

⁸⁶ Glaze, Ben (2008) "Protest sees 13 arrested." [South Wales Echo](#). April 4, 2008.

plant is to be built.⁸⁷ People are also criticizing the World Bank's International Finance Corporation, which is providing assistance for a 4000 MW, \$4.5B non-capture plant in India while concurrently supporting the reduction of carbon emissions.⁸⁸ The issue of permitting new coal plants is increasingly being taken up by environmental and public interest groups through both legislation and social opposition, only adding to the difficulty in building new plants to meet electrical demand.

In response to the widespread opposition to coal, organizations have emerged to tout the benefits and positive environmental aspects of coal. The non-profit organization American for Balanced Energy Choices (ABEC), formed in 2000⁸⁹ and funded by 28 leading coal and power companies, launched the \$35M "America's Power" publicity campaign, much of which promotes how clean modern coal technology is.⁹⁰ In one month, the organization spent \$750,000 on television, billboard, newspaper, and radio ads in Ohio alone.⁹¹ In April 2008, ABEC merged with the Center for Energy and Economic Development (CEED), which had worked on coal-based electricity issues at regional, state, and local levels. The result was the American Coalition for Clean Coal Electricity (ACCCE) with more than 48 major companies as members.⁹² With a budget of more than \$45M, ACCCE is aimed at advocating the economic and environmental benefits of coal through public outreach and the support of public policies.⁹³ In 2007, ACCCE

⁸⁷ Matlock, Staci (2007) "2007 Legislature: Opposition to Power Plant Builds Steam." The New Mexican. January 28, 2007.

⁸⁸ Wroughton, Lesley (2008) "Green groups oppose World Bank's India coal plant." Reuters. April 7, 2008.

⁸⁹ "New Multi-Industry Coalition Aligns to Advocate Energy Security and Environmental Stewardship." (2008) BusinessWire. April 17, 2008.

⁹⁰ Mufson, Steven (2008) "Coal Industry Plugs Into the Campaign." Washington Post. January 18, 2008.

⁹¹ Hunt, Spencer (2008) "Energy companies plug coal's 'clean' benefits." The Columbus Dispatch. March 31, 2008.

⁹² Weiss, Daniel J., Nick Kong, et al. (2008) "The Clean Coal Smoke Screen." Center for American Progress. December 22, 2008.

⁹³ "New Multi-Industry Coalition Aligns to Advocate Energy Security and Environmental Stewardship."

spent \$18M on television commercials.⁹⁴ The lobbying groups for coal interests have also increased their budgets and efforts.⁹⁵

In response to creation of the ACCCE and their media campaign promoting “clean coal,” a new organization of five environmental groups, including the Sierra Club and National Resources Defense Council, came together as the “Reality Coalition.” Their goal is “to educate the public, media, and public officials ‘that in reality, there is no such thing as “clean coal.””⁹⁶ They also launched a large media campaign. A group founded by former Vice President, the Alliance for Climate Protection, is also acting to undermine faith in clean coal technology. They spent \$48M on television commercials in 2007, and intend to spend \$300M on their campaign over three years. Its initial commercial made quite an impression as an engineer in a hardhat led cameras around a “clean coal facility,” actually an empty landscape.⁹⁷ The potential impact of such well-supported campaigns both for and against coal is not to be neglected, especially as it is playing out in America’s living rooms.

3.5 REGIONAL AND STATE INITIATIVES

The past decade has increasingly seen states taking initiatives to address their own carbon emissions through participating in regional climate change programs, mandating emissions performance standards, or specifying substantial emissions reduction goals. Each of these has a strong impact on whether a plant serving a participating state could be a wise investment.

As early as 2001, various regional organizations started forming with the intention of addressing emissions of greenhouse gases. There are three organizations that establish market-based systems for carbon dioxide emissions. These cap-and-trade programs will operate similarly to the programs proposed in federal legislation. Some details of these programs are presented in the table below.

⁹⁴ Whitten, Daniel (2009) "Clean-Coal Debate Pits Al Gore's Group Against Obama, Peabody." [Bloomberg](#). February 4, 2009.

⁹⁵ Mufson

⁹⁶ Weiss, Kong, et al. "The Clean Coal Smoke Screen."

⁹⁷ Whitten

Table 3-1. Regional Market-Based Programs

Initiative	<i>Regional Greenhouse Gas Initiative (RGGI)</i> ⁹⁸	<i>Western Climate Initiative</i> ⁹⁹	<i>Midwest Regional Greenhouse Gas Reduction Accord (MRGHGRA)</i> ¹⁰⁰
Initiated	2003	2007	2007
Mechanism	Cap-and-Trade	Cap-and-Trade	Cap-and-Trade
Coverage	Initially power plants only	Multi-sector	Multi-sector
Reduction Goals	Cap at average of 2000-2004 levels in 2009, 10% below that by 2019	15% below 2005 by 2020	Long-term: 60-80%

Twenty-three states, plus four Canadian provinces, are now participants in these programs, with many others signed on as observers. The map below indicates states participating in each agreement.

⁹⁸ "Regional Initiatives." (2009) The Pew Center on Global Climate Change. Retrieved January 20, 2009, from http://www.pewclimate.org/what_s_being_done/in_the_states/regional_initiatives.cfm.; "Overview of RGGI CO2 Budget Trading Program." (2007) Regional Greenhouse Gas Initiative. October 2007.; "Regional Greenhouse Gas Initiative." (2009) Regional Greenhouse Gas Initiative. Retrieved January 21, 2009, from <http://www.rggi.org/home>.

⁹⁹ "Regional Initiatives.;" "States, Provinces Taking Action to Curb Climate Change." (2008) Western Climate Initiative. May 15, 2008.; "The Western Climate Initiative." (2008) The Western Climate Initiative. Retrieved August 21, 2008, from <http://www.westernclimateinitiative.org/>.

¹⁰⁰ "Regional Initiatives."

Figure 3-2. Regional Market-Based Program Participants¹⁰¹

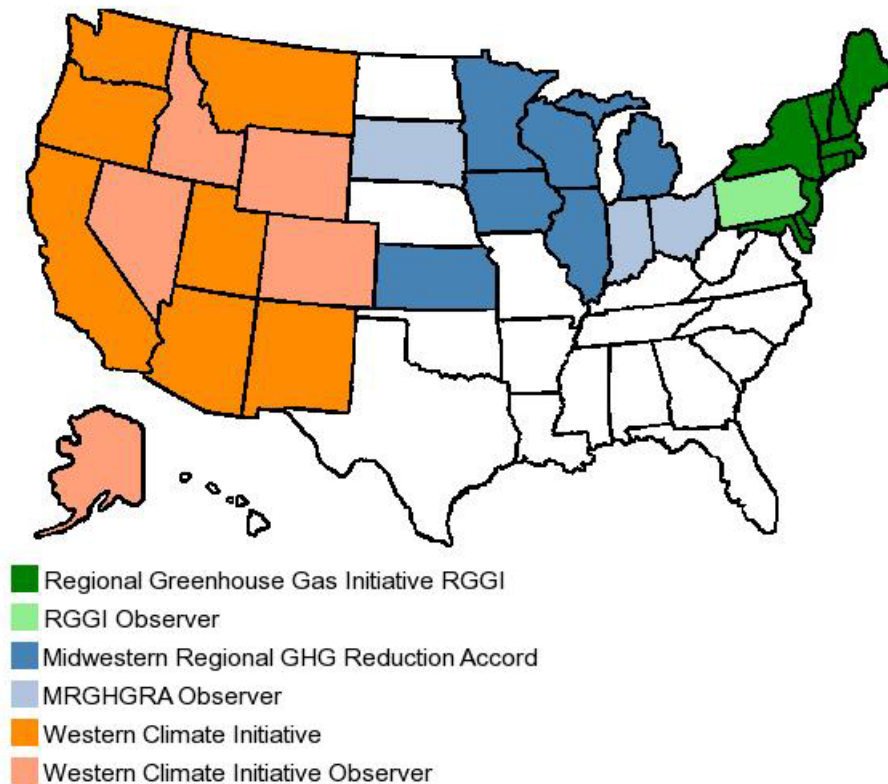

The Regional Greenhouse Gas Initiative (RGGI), which resulted from the New England Governors: Climate Change Action Plan (NEG-ECP), is currently the organization with the most advanced development. RGGI permit auctions began in 2009 and resulted in permit prices below \$4.00 per ton CO₂.¹⁰² Both the Western Climate Initiative and the Midwest Regional Greenhouse Gas Accord are still in the process of developing their programs.¹⁰³ Because these systems are not yet fully running, it is difficult to predict the extent of their impact on the building of new coal-fired power plants. While they will certainly increase the cost of plants, having these schemes decided and functioning will resolve some of the uncertainty about the type and cost of carbon regulations that has contributed to coal paralysis. Whether the former or latter effect dominates will likely be determined by the emissions caps and subsequent prices for permits.

¹⁰¹ Adapted from Ibid.

¹⁰² "Regional Greenhouse Gas Initiative."

¹⁰³ "Regional Initiatives."

Two states have notably adopted limits on the emissions of carbon dioxide from coal-fired power plants. In October 2005, California's Public Utility Commission issued a statement indicating its intention to adopt a policy to cap greenhouse gas emissions from power generators. On January 25, 2007, the Commission implemented Senate Bill 1368, an Emissions Performance Standard (EPS) for most types of energy providers. It sets an emissions limit of 1,100 lbs CO₂ per MWh for any "new plant investments (new construction), new or renewal contracts with a term of five years or more, or major investment by the utility in its existing baseload power plants."¹⁰⁴ The level was chosen as comparable to a well-functioning new natural gas combined cycle plant. The standard applies to any projects that serve California, regardless of the physical location of the project, and thus has cross-border implications.¹⁰⁵

The state of Washington likewise adopted an EPS of 1,100 lbs CO₂ per MWh in May 2007. Substitute Senate Bill 6001, which also established state-wide emissions reduction goals, imposed Washington's EPS, which was very closely modeled on California's Senate Bill 1368.¹⁰⁶ Six months later this resulted in the denial of a permit for Energy Northwest's 793 MW Pacific Mountain Energy Center because it did not meet the standard.¹⁰⁷ The new law was specifically cited when Avista Utilities purged at least one coal plant from its strategy upon completion of its 2007 Integrated Resource Plan.¹⁰⁸

¹⁰⁴ "California Public Utilities Sets Greenhouse Gas Emissions Performance Standard." (2007) California Public Utilities Commission. January 25, 2007.; "Final Workshop Report: Interim Emissions Performance Standard Program Framework, R.06-04-009, June 21-23, 2006." (2006) California Public Utilities Commission, Division of Strategic Planning. October 2, 2006.

¹⁰⁵ "California Public Utilities Sets Greenhouse Gas Emissions Performance Standard." "Final Workshop Report: Interim Emissions Performance Standard Program Framework, R.06-04-009, June 21-23, 2006."

¹⁰⁶ "Climate Change Law Alert: Washington State Adopts GHG Emissions Reduction Legislation." (2008) Stoel Rives Energy Group. May 4, 2007.; Ecke, Richard (2008) "Plant needs to meet new standards to sell power to Washington." Great Falls Tribute. June 29, 2008.

¹⁰⁷ Robinson, Erik (2007) "Power plant plan to drop new coal technology." Spokesman Review. December 23, 2007.; Ecke

¹⁰⁸ "Avista Issues Electric Resource Plan." (2007) Avista Corporation. September 4, 2007.

While these standards have no impact on existing plants, it certainly reduces the ease with which new projects can be permitted in-state, and influences out-of-state business decisions about projects that intend to sell their electricity into California or Washington. It is likely that this will increase preferential investment in natural gas plants, although CCS projects on coal-fired power plants could also be used to meet the standard. The emissions rate is to be determined over the lifetime of the plant, meaning that suitable plans for future sequestration projects can qualify plants for permitting even if they do not meet the EPS immediately, contingent upon commencement of sequestration within five years of plant operation, and subject to penalties for failing to do so.¹⁰⁹ Until utilities can count on the timely installation and operation of CCS, however, these emissions performance standards amount to a de-facto moratorium on all coal-fired power plants.

At the Florida Climate Change Summit, on July 13, 2007, Governor Crist issued an executive order announcing new greenhouse gas emission reductions for the state. The state's goals are a reduction to 1990 levels by 2017, representing a 25% reduction from then current levels, and a further 20% reduction by 2050. Separate reduction goals for power plants were issued: 2000 emissions levels by 2017, 1990 levels by 2025, and an 80% reduction from 1990 levels by 2050.¹¹⁰ In June 2008 Governor Crist signed into law legislation that enacts a cap-and-trade system for electrical generating utilities, the only single-state cap-and-trade system in the country. The program, potentially beginning as early as January 2010, will be designed to ensure that power plants meet their sector-specific emissions reduction goals.¹¹¹

Even anticipation of the emissions reduction executive order was enough to impel the suspension of plans for a new plant. The 800 MW Taylor Energy Center, a joint venture by four

¹⁰⁹ "Climate Change Law Alert: Washington State Adopts GHG Emissions Reduction Legislation."

¹¹⁰ Executive Order Number 07-127: Establishing Immediate Actions to Reduce Greenhouse Gas Emissions within Florida. (2007) Office of the Governor, State of Florida. July 13, 2007.

¹¹¹ "Regional Initiatives."

community-owned utilities, suspended its permitting activities on the eve of the Summit.¹¹² Furthermore, in October, Tampa Electric shelved its plans for an 630 MW expansion of the Polk Power Station, citing uncertainties about the cost of controlling emissions.¹¹³ Concerns over potential carbon controls also led to cancellation of Orlando Utilities Commission and Southern Company's plan for a 285 MW IGCC project, the Stanton Energy Center, in November 2007.¹¹⁴ It can be expected that these executive orders and similar initiatives in other states will continue to deter plans for new coal-fired power plants.

3.6 UTILITY INITIATIVES

Utilities are more often proactively taking it upon themselves to pursue projects that utilize energy sources other than coal, whether from public pressure, environmental stewardship, or in anticipation of federal climate legislation that could make coal plants less economic. Many plant cancellations, and even the closure of two plants, reflect this voluntary shift away from coal. Xcel Energy announced that it wants to reduce its carbon emissions 10% by 2015, leading them to close two existing coal plants in favor of wind, solar, and a natural gas plant.¹¹⁵ Idaho Power Company chose to invest in 101 MW of wind power, 45.5 MW of geothermal, and a natural gas turbine instead of a 250 MW coal plant.¹¹⁶ Citing public opposition to coal, Rochester Gas and Electric shifted the fuel source for its proposed 300 MW plant to natural gas from coal.¹¹⁷

3.7 REGULATORY ISSUES

When evaluating requests for air permits for new plants, environmental regulators have denied permits or made specific demands motivated by concerns over climate change and other air

¹¹² "JEA kills plans for Taylor County power plant." (2007) Jacksonville Business Journal. July 3, 2007.; "Taylor Energy Center to Suspend Plant Permitting and Participate in State Dialogue on Florida's Energy Future." (2007) City of Tallahassee. July 3, 2007.

¹¹³ "Tampa Electric Cancels Plans for New Coal Plant in Florida." (2007) EnergyOnline News. October 5, 2007.

¹¹⁴ "IGCC stumbles and falls in the US. The spate of cancellations is becoming a flood." (2007) Modern Power Systems. November 26, 2007.

¹¹⁵ Raghaven, Sreekumar (2008) "Why is Tata Power silent on Mundra power plant?" International Business Times. April 8, 2008.

¹¹⁶ Brown, Matthew (2007) "Idaho Power gives up on coal-fired plant." Idaho Stateman. November 7, 2007.

¹¹⁷ Wallace, Daniel (2007) "Russell Station plans change." Rochester Democrat and Chronicle. September 29, 2007.

pollutants. For example, the permit for Seminole Electric Power Cooperative's 750 MW plant was denied by Florida's Department of Environmental Protection for failing to minimize impacts to the environment and public health.¹¹⁸ NRG was informed by state officials that its proposed 680 MW IGCC Huntley station in New York must include CCS, resulting in a project too expensive to pursue.¹¹⁹ Regulators in Michigan and North Carolina have made retirement of older, less efficient plants a condition of the permit approvals for some new plants.¹²⁰ Two other issues, oscillation of regulatory signals and technology preferences, further complicate the regulatory realm.

In April 2007, the U.S. Supreme Court made a landmark decision that altered the landscape of carbon dioxide debates and gave credence to regulatory requirements. In the case *Massachusetts v. EPA*, Massachusetts and eleven other states, plus three cities, sued the U.S. Environmental Protection Agency (EPA) over its failure to regulate carbon dioxide emissions. They sought to force the EPA to regulate emissions from new motor vehicles. The EPA had previously taken the stance that doing so interfered with the U.S. Department of Transportation's authority to regulate fuel economy standards, and that even if they had the authority to regulate under the Clean Air Act, they would decline to do so. The Supreme Court held that greenhouse gas emissions do fit the definition of a pollutant under the Clean Air Act, and thus the EPA has authority to regulate them. They further determined that the EPA's justification for declining to regulate was inadequate, and thus mandated that they either provide suitable justification or develop emissions standards.¹²¹

¹¹⁸ "Stopping the Coal Rush."

¹¹⁹ Robinson, David (2008) "State Scrubs Clean Coal Power Plant; Huntley Project Too Costly; Plans for Sequestering Carbon Dioxide Doubted." Buffalo News. July 17, 2008.; Robinson, David (2008) "Huntley dream was just too speculative." Buffalo News. July 20, 2008.; Fanelli, Patrick (2008) "NYPA Withdraws Support For North Tonawanda Clean Coal Project." Post-Journal. July 17, 2008.

¹²⁰ O'Grady, Eileen (2007) "Kentucky advanced-coal projects obtains air permit." Reuters. November 30, 2007.; "Mr. Rogers Responds: Duke Energy CEO responds to climate scientist Jim Hansen." (2008) Grist. April 2, 2008.

¹²¹ *Massachusetts et al. v. Environmental Protection Agency et al.* (2007) Supreme Court of the United States. Decided April 2, 2007.

The determination that carbon dioxide qualifies as a regulation-qualifying, indeed a regulation-deserving pollutant gave regulators greater freedom to make strong carbon-related demands regarding emission sources such as power plants. Most notably, the air permit for the addition of two 700 MW units to a Sunflower Electric Power Cooperative plant near Holcomb, Kansas was denied in September by the Kansas Department of Health and Environment (KDHE). The Director of the KDHE specifically cited the *Massachusetts v. EPA* Supreme Court decision, and said it would be “irresponsible” to ignore climate change concerns when making permitting decisions.¹²² The Kansas City Board of Public Utilities abandoned plans for a new 235 MW plant shortly afterward, likely in recognition that they would encounter the same difficulty.¹²³

In Georgia, the Sierra Club challenged an air permit for a new 1200 MW plant in court, and the judge in the case ruled the permit invalid because the plant did not plan to address its carbon emissions, citing the Supreme Court decision.¹²⁴ This represented the first time a court had ruled against a permit due to uncontrolled carbon emissions.¹²⁵

The debate over the air permit for a 110 MW plant in Vernal, Utah brought the issue back to the federal EPA and national press.¹²⁶ Deseret Power had been granted an air permit for their Bonanza Generating Station in July 2007 by the EPA’s Denver office. The Sierra Club sued, and the case eventually went to the EPA’s Environmental Appeals Board. On November 13, 2008, the Board found that the Denver office had “failed to adequately support its decision to issue a permit for the Bonanza plant without requiring controls on carbon dioxide,” citing the *Massachusetts v. EPA* ruling. The matter was relegated back to the Denver office with instructions to better justify its decision.¹²⁷

¹²² Mufson, Steven (2007) "Power Plant Rejected Over Carbon Dioxide For First Time." Washington Post. October 19, 2007.

¹²³ "Stopping the Coal Rush."

¹²⁴ O'Grady, Eileen (2008) "Georgia court cites carbon in coal-plant ruling." Reuters. June 30, 2008.

¹²⁵ Wald, Matthew L. (2008) "Georgia Judge Cites Carbon Dioxide in Denying Coal Plant Permit." The New York Times. July 1, 2008.

¹²⁶ Walsh, Bryan (2008) Environmentalists Win Big EPA Ruling. Time. November 13, 2008.

¹²⁷ Hebert, H. Josef (2008) "Coal plants jeopardized over climate." USA Today. November 14, 2008.

This was essentially a clear signal from the EPA that coal-fired power plants would not be permitted until the EPA determines how it should regulate carbon dioxide under the Clean Air Act. The ruling put into question the fate of as many as 100 plants that were under various stages of development at the time.¹²⁸ As Bruce Nilles of the Sierra Club stated, “In the short term it freezes the coal industry in its tracks.”¹²⁹

The tables were turned again when, on December 19, 2009, then-EPA administrator Stephen L. Johnson issued a memorandum that overturned the Environmental Appeals Board’s decision, stating that the board had confused the federal and state environmental agencies and misinterpreted the regulation. He claimed that regulation of carbon dioxide is not to be considered when approving power plants permits. Utilities and power producers were given one strong signal about the viability of their permits initially, only to have it completely reversed five weeks later. This type of regulatory fluctuation makes it extremely difficult for companies to make wise business decisions.¹³⁰

Once the executive administration of the United States government changed in January 2009, the issue reversed again. Seemingly in defiance of Johnson’s memorandum, the Deseret Power decision was cited in the Environmental Appeals Board’s decisions to withdraw a portion of an air permit for the Desert Rock power plant in New Mexico and to remand the permit for a new boiler at Northern Michigan University.¹³¹ Carol Browner, special advisor to President Obama on climate change and energy, announced on February 22, 2009 that the EPA would once again consider regulating carbon dioxide, as originally ordered in the Supreme Court ruling.¹³² On

¹²⁸ Ibid.

¹²⁹ Walsh.

¹³⁰ Wald, Matthew L. and Felicity Barringer (2008) "E.P.A. Ruling Could Speed Up Approval of Coal Plants." The New York Times. December 19, 2008.

¹³¹ Helms, Kathy and Dine Bureau (2009) "EPA withdraws portion of Desert Rock permit." Gallup Independent. January 26, 2009.; "Citing GHG emissions, EPA board remands Mich. permits." (2009) Environment & Energy Daily. February 20, 2009.

¹³² Talley, Ian (2009) "EPA Set to Move Toward Carbon-Dioxide Regulation." The Wall Street Journal. February 23, 2009.

April 17, 2009 the EPA issued a proposed finding that carbon dioxide emissions do present an endangerment, to be followed by a public comment period and then possibly the proposal of rule-making.¹³³

The type of technology that is preferable has also been addressed by some regulators. In areas that have attained a certain level of air quality, the Clean Air Act requires that Best Available Control Technology (BACT) be used to control regulated pollutants. Although the *Massachusetts v. EPA* ruling declared that carbon dioxide is a regulated pollutant, the EPA has not determined what the BACT for it should be. This issue, as well as whether IGCC can be considered BACT, is a predominant sticking point in many of the recent regulatory battles.

IGCC plants typically have lower emissions of pollutants including sulfur dioxide, nitrogen oxides, particulates, and mercury than pulverized coal plants.¹³⁴ This has led some environmental groups and regulators to push for the requirement that IGCC be considered in the analysis of Best Available Control Technology (BACT) when applying for permits for a PC plant.

In 2005 the EPA issued a memo stating that IGCC is an “alternative” to a PC plant because the IGCC process is so different that it would require a redesign of the entire plant, and different expertise deriving more from the refining and chemical manufacturing industries due to the chemical reaction nature of the process as opposed to true combustion. The classification of IGCC as an “alternative” to PC, just as is a natural gas plant, exempts it from consideration in a

¹³³ "EPA Finds Greenhouse Gases Pose Threat to Public Health, Welfare / Proposed Finding Comes in Response to 2007 Supreme Court Ruling." (2009) U.S. Department of Energy, U.S. Environmental Protection Agency. April 17, 2009.

¹³⁴ "Fact Sheet: Environmental Permitting of Coal-Fired Power Plants in Michigan." (2007) Michigan Department of Environmental Quality. June 29, 2007.

BACT analysis, according to the EPA.¹³⁵ Groups including the Clean Air Task Force have challenged the decision.¹³⁶

Nevertheless, some have taken the opposite position at the state level. The states of New Mexico, Kentucky, Illinois, and Montana require that IGCC be considered an option in BACT analysis.¹³⁷ This has the potential to ensure that no PC plants are built, and the higher capital costs of a non-capture IGCC plant versus a non-capture PC plant could make new power projects less economic. These requirements were strongly influenced by lawsuits from environmental groups such as the Sierra Club and the Clean Air Task Force.¹³⁸ The Michigan Department of Environmental Quality initially recommended that IGCC be considered in BACT analyses, but later agreed to address the issue on a case-by-case basis.¹³⁹ The issue was also addressed in Wisconsin, but a court ruled against requiring consideration of IGCC.¹⁴⁰

This issue, along with the Supreme Court ruling designating carbon dioxide as a pollutant, and the oscillation of the EPA's position, complicate the building of new power plants.

3.8 CASE STUDY: A TORNADO OF ISSUES IN KANSAS

The story surrounding the proposal for a plant in western Kansas serves as a fascinating case study, bringing together many of the pervasive issues discussed above including escalating costs,

¹³⁵ Page, Stephen D. (2005) "Best Available Control Technology Requirements for Proposed Coal-Fired Power Plant Projects." Personal Communication. December 13, 2005.

¹³⁶ Loftis

¹³⁷ "Fact Sheet: Environmental Permitting of Coal-Fired Power Plants in Michigan." ; Fowler, Mike (2003) "Permit Application No. 2663, Mustang Generating Station, Revised BACT Analysis." Personal Communication. August 29, 2003.; McElligott, Suzanne (2007) "Sierra Club Pushes IGCC as BACT in Kentucky." August 22, 2007.; "IGCC Engineering and Permitting Issues Summaries." (2006) Energy Center of Wisconsin, Clean Coal Study Group. April 2006.

¹³⁸ McElligott

¹³⁹ "Fact Sheet: Environmental Permitting of Coal-Fired Power Plants in Michigan." ; Chester, Steven E. (2007) "Decision of the MDEQ Regarding IGCC in BACT Analysis." Personal Communication. December 20, 2007.

¹⁴⁰ Strangmeier, Suzanna (2005) "TXU adding to coal fleet, expand beyond Texas." Natural Gas Week. November 14, 2005.

state initiatives and legislation, opposition from individuals and organizations, and regulators' decisions. This convergence of issues in a unique case garnered national attention.

Sunflower Electric Power Cooperative proposed installing three 700 MW units as an expansion of its generating station near the small town of Holcomb in western Kansas. The plan included an experimental bioenergy center to grow algae on the carbon dioxide in the plant's flue gas, designed to sequester up to 4% of the plant's 11 million tons of carbon dioxide a year.¹⁴¹ Initially only 15% of the electricity generated would serve Kansas customers; the rest would be transmitted to Colorado and Texas.¹⁴² Colorado enacted a law requiring that rural electric cooperatives get 10% of their power from renewable resources, the likely cause of Sunflower Electric cancellation of one of the units, once again showing the impact of a state initiative.¹⁴³ The utility continued with its plans for the other two units, despite the fact that the projected cost had doubled to \$4.2B.

On October 18 2007, the Secretary of the Kansas Department of Health and Environment (KDHE), Rod Bremby, denied the air permit for the project, saying "I believe it would be irresponsible to ignore emerging information about the contribution of carbon dioxide and other greenhouse gases to climate change and the potential harm to our environment and health if we do nothing."¹⁴⁴ As mentioned above, he specifically cited the *Massachusetts v. EPA* Supreme Court decision in the announcement of his denial.¹⁴⁵

The regulator's air permit denial over concerns about climate change initiated a whirlwind of over 30 articles and editorials that appeared over the following weeks in *The Wichita Eagle*, a Kansas newspaper. Local, state, and federal politicians, prominent local businessmen, and concerned citizens chimed in either in support or criticism of the decision. Governor Kathleen

¹⁴¹ Schrag, Duane (2008) "Coal plant's bioreactor would start small." *Salina Journal*. February 22, 2008.

¹⁴² Sebelius, Kathleen (2007) "Permit denial was correct decision." *The Wichita Eagle*. October 28, 2007.

¹⁴³ Mufson "Power Plant Rejected Over Carbon Dioxide For First Time." ; Carpenter

¹⁴⁴ "KDHE Denies Sunflower Electric Air Quality Permit." (2007) Kansas Department of Health and Environment. October 18, 2007.

¹⁴⁵ Ibid.

Sebelius defended the decision, pointing out that Kansas would receive only 15% of the electricity, yet 100% of the pollution and carbon emissions associated with the project.¹⁴⁶ An opinion poll showed that two out of three residents were opposed to the Holcomb project.¹⁴⁷ Others, including the President of the Kansas Senate and the Speaker of the Kansas House, decried the decision, saying that it was beyond the regulator's authority to deny a permit for emissions of an unregulated substance and that it was based on Bremby's "*opinion* that additional carbon dioxide in the atmosphere presents a substantial endangerment to public health."¹⁴⁸ Proponents of the plant also pointed out that the transmission lines that would have been built with the project would have facilitated the development of wind farms, and that the algae experiment would have helped develop technologies to fight climate change.¹⁴⁹

A series of full-page advertisements taking a position on the plant also appeared in the newspapers. A group called "Know Your Power Kansas" publicized serious health risks associated with pollution from coal plants.¹⁵⁰ It was followed by an advertisement from "Kansans for Affordable Power" that called attention to the facts that natural gas prices had risen, some natural gas is imported, and coal is cheap and plentiful in the United States. One line read, "Without new coal-fueled plants in our state, experts predict that electric bills will skyrocket and Kansans will be more dependent than ever on hostile, foreign energy sources."¹⁵¹ Know Your Power Kansas responded with an advertisement that point-for-point identified inaccuracies in Kansans for Affordable Energy's ad.¹⁵² It was later revealed that Know Your Power Kansas was funded by an Oklahoma natural gas company¹⁵³ and Kansans for Affordable Power's funding

¹⁴⁶ Sebelius

¹⁴⁷ Mufson "Coal Industry Plugs Into the Campaign."

¹⁴⁸ Morris, Stephen and Melvin Neufeld (2007) "Plant decision wrong." The Wichita Eagle. November 4, 2007.

¹⁴⁹ Ibid.

¹⁵⁰ "Kansas Stands Up Against Coal Pollution" (Advertisement). (2007) The Wichita Eagle, Know Your Power Kansas. October 24, 2007.

¹⁵¹ "Why are these men smiling?" (Advertisement). (2007) The Wichita Eagle, Kansans for Affordable Power. November 6, 2007.

¹⁵² "Know Your Power to Know the Truth" (Advertisement). (2007) The Wichita Eagle, Know Your Power Kansas. November 11, 2007.

¹⁵³ Lefler, Dion (2007) "Anti-coal campaign irritates legislators." The Wichita Eagle. October 28, 2007.

came from sources including the world's largest private-sector coal company and Sunflower Electric.¹⁵⁴ Many were outraged that what seemed like grassroots social organizations were funded by energy companies, and discussion about the series of events surrounding the plant extended far beyond Kansas.¹⁵⁵

After the immediate furor over the plant and the KDHE's denial of the air permit, a bill was introduced in Kansas's Congress that would establish rules that required approval of the permit, but Sebelius vetoed it.¹⁵⁶ A similar bill, introduced only two days later, would have forced permitting by implementing a generous emission performance standard. It still contained the provisions Sebelius had opposed, such as a rule that would prevent the KDHE from imposing any regulations that were stricter than federal pollution standards without legislative approval. This second bill and a similar third bill have also been vetoed by the Governor. Sunflower Electric has sued the Sebelius administration in federal court, citing a lack of fair and equal treatment.¹⁵⁷ A bill was also introduced into the state House of Representatives that would require new electric power plants to capture 45% of their emissions, but the bill is strongly opposed by the regional utility companies, so its fate is questionable.¹⁵⁸

This series of events surrounding a single coal-fired power plant project in a remote area of Kansas is notable for its inclusion of many of the challenges other plants encounter. The Sunflower Electric plant proposal faced a cancellation due to a Colorado state initiative and a doubling of project costs. It got wrapped up in a debate regarding regulation of carbon dioxide and inspired vigorous participation by the citizenry.¹⁵⁹ All of these issues converged regarding

¹⁵⁴ Lefler, Dion (2007) "Coal backers defend their ad's claims." [The Wichita Eagle](#). November 6, 2007.; Power, Stephen (2008) "Kansan Stokes Energy Squabble With Coal Ruling." [The Wall Street Journal](#). March 19, 2008.

¹⁵⁵ Lefler "Anti-coal campaign irritates legislators." ; Lefler "Coal backers defend their ad's claims."

¹⁵⁶ Hanna, John (2008) "New bill on coal-fired plants emerges in Kansas House." [The Kansas City Star](#). March 24, 2008.

¹⁵⁷ "Three Strikes Against Kansas Coal Plants: Sebelius Vetoes Again." (2008) [Environment News Service](#). May 16, 2008.

¹⁵⁸ "Lawrence legislator angers many with his proposed energy bill." (2009) [Lawrence Journal-World](#). January 26, 2009.

¹⁵⁹ Power

one project, generating national attention in both the *Wall Street Journal* and the *Washington Post*, and provides a fascinating case study of the challenges facing coal-fired power plants.¹⁶⁰

3.9 THE PREVALENCE OF UNCERTAINTY

Many of the difficulties facing plants, while providing challenges themselves, also generate large uncertainties. Without knowing exactly what impact federal legislation or state participation in a cap-and-trade system will have on the economics of a plant, how much more costs will rise, and what kind of legal, public, and regulatory opposition will be encountered, utilities simply do not have sufficient information to evaluate whether a coal-fired power project is a wise investment over its lifetime.

This prevalence of uncertainty has been cited in the cancellation of multiple projects, and undoubtedly was a contributing factor in many others. The Tennessee Valley Authority cited uncertain economics in its decision to build a \$2.5B nuclear facility instead of a new coal plant.¹⁶¹ A jointly-held project between Idaho Power and PacifiCorp, a 600 MW addition to the Jim Bridger station, was abandoned due to “the uncertain political climate regarding carbon dioxide emissions.”¹⁶² Uncertainty about future carbon dioxide restrictions in Florida contributed to the cancellation of the 285 MW IGCC Stanton Energy Center, a joint venture by Orlando Utilities Commission and Southern Company, although ground had already been broken on the project.¹⁶³ Southwestern Power Group blamed economics and regulatory uncertainty for the abandonment of the 600 MW IGCC Bowie Power Station in Arizona in favor of a natural gas plant.¹⁶⁴ When a Westmoreland Power plant in North Dakota was cancelled, a company representative summed up the issue in a letter to the North Dakota Industrial Commission: “There is much uncertainty in the utility sector on when future carbon regulation will come into

¹⁶⁰ Ibid.; Mufson "Coal Industry Plugs Into the Campaign."

¹⁶¹ Raghaven

¹⁶² "PacifiCorp cancels Wyo. coal projects." (2007) Wyoming Tribune Eagle. December 11, 2007.

¹⁶³ "IGCC stumbles and falls in the US. The spate of cancellations is becoming a flood."

¹⁶⁴ "Bowie Power Station Announces Plan to Run Solely on Clean Natural Gas." (2007) Energy-Arizona. August 31, 2007.

effect. This has slowed the development of coal-fired power plants.”¹⁶⁵ While not all of the issues presented can be proactively resolved, it seems that only the deployment of CCS and resolution of uncertainties, especially regarding federal legislation and regulation, will work to mitigate the coal paralysis and provide baseload electrical generation while also addressing concerns about climate change.

¹⁶⁵ Wetzel, Dale (2008) "Coal company suspends efforts to build N.D. power plant." The Bismarck Tribune. May 21, 2008.

4 SCENARIOS FOR THE FUTURE

4.1 BUSINESS-AS-USUAL

In the absence of governmental influence, it is likely that the current difficulty in permitting and building coal-fired power plants will continue and possibly escalate. In this business-as-usual case, natural gas is likely to become the preferred fuel, referred to as fuel-switching. This increase in reliance on natural gas could have important implications. As consumption of natural gas increases, imports of natural gas will possibly have to increase to meet demand. This means that the United States will be relying on foreign sources for an increasing share of the resource mix, thereby reducing energy security and independence. Increased consumption will also likely lead to exacerbation of already high and volatile prices; this will be reflected in the rates electricity consumers pay.¹⁶⁶

The coal paralysis may also continue to prevent CCS from being demonstrated and implemented. Under a cap-and-trade system, this may push natural gas prices even higher.¹⁶⁷ Without the development of the CCS industry, the emissions from natural gas may be locked-in, meaning that these plants will not be retrofitted with CCS and their emissions will continue to contribute to climate change.

4.2 POLICY OPTIONS

Some level of government intervention is expected, however. As discussed in Chapter 3, the Environmental Protection Agency may make decisions regarding how to regulate carbon dioxide emissions from new coal-fired power plants, or climate change legislation may set emissions performance standards. While a cap-and-trade system would be designed to reduce emissions across the economy, standards will possibly be an additional measure to specifically address emissions from power plants due to their contribution to climate change. Given that the

¹⁶⁶ "The Urgency of Sustainable Coal." (2008) The National Coal Council. May 2008.

¹⁶⁷ Hoppock, Dave, Patrick Bean, et al. (2009) "The Influence of Technology and a Carbon Cap on Natural Gas Markets." Duke University, Climate Change Policy Partnership. March 2009.

regulation or legislation is likely to specify a certain amount of capture or a required emissions rate, the level at which the standard is set will have important consequences.

If the standard is too lenient, meaningful emissions reductions will not take place. The CCS industry will develop slowly, if at all. There will also be strong resistance to a lenient standard by the same environmental and public advocacy groups that fight the building of coal plants. If the standard is unacceptable to the states, they may also begin crafting separate regulations, resulting in a national patchwork of different regulations. The uncertainty that contributes to the coal paralysis may continue.

If the standard is too strict, companies are unlikely to undertake the financial and technological risk associated with high levels of carbon capture, especially when they can simply switch to natural gas. This will result in a situation similar to the business-as-usual scenario, with overreliance on natural gas from foreign sources and high and unpredictable prices. Furthermore, fuel-switching means that emissions reductions intended by the standard will not actually take place; emissions will only be reduced to those from natural gas. It is unlikely that natural gas plants would be originally designed for or retrofitted with equipment for CCS because, although it is possible, it is uneconomic compared to coal plants. This will result in the emissions from these plants being locked-in. Importantly, this will also hinder the development of carbon capture and storage technology.

A third option represents the most feasible path forward: a moderate standard that would make carbon dioxide emissions from coal comparable to natural gas, or “natural gas parity.” This may be represented as roughly 40-65% capture, dependent on the plants being compared, or emissions levels in the range of 800-1,100 lbs/MWh.¹⁶⁸ By creating a level playing field for coal and natural gas, this would achieve three important goals:

- Climate Change: Meaningful reduction of carbon dioxide emissions.

¹⁶⁸ It is important to note that these standards could be met through either constant operation of a capture system designed to achieve the standard, or flexible operation of a capture system designed to capture more than the standard. For more information see "Carbon Capture and Sequestration: Framing the Issues for Regulation." (2008) The CCSReg Project. December 2008.

- Energy Security: A diversified portfolio of options for electricity generation and use of a plentiful domestic resource instead of overreliance on foreign sources.
- Consumer Protection: A hedge against high electricity prices associated with natural gas, which may become even higher under a cap-and-trade system.

Furthermore, by reducing the financial and technological risk associated with capture, it is likely that partial-capture CCS could actually be implemented by individual companies. By getting these systems on the ground and running, the development and deployment of full-capture CCS will be expedited due to crucial learning and likely cost reductions.

4.3 POLICY MOMENTUM

In recognition of the practicality of this approach, the idea of partial capture, and natural gas parity in particular, is starting to gain policy traction. The level of the California and Washington emissions performance standard, 1,100 lbs/MWh, was chosen as a practical standard because it would still allow natural gas plants to be built.¹⁶⁹ It was not intended to facilitate partial-capture CCS, but it is now recognized that partial capture could be used to meet it. The U.K. Conservative Party has proposed the same standard.¹⁷⁰ The European Parliament environment committee also voted to establish an 1,100 lbs/MWh standard, although the associated Directive must pass more hurdles before being enacted.¹⁷¹

Various levels of capture are also being used in state incentives provided for some new coal facilities. A new Illinois law, the "Clean Coal Portfolio Standard Act," SB 1987, requires that electricity suppliers and utilities purchase up to 5% of their power from clean coal facilities. It specifies that these facilities must be coal gasification facilities that capture and store at least 50% of their carbon dioxide emissions, and that emissions of other regulated pollutants must be no higher than a natural gas combined-cycle plant.¹⁷² A bill proposed in Texas would provide

¹⁶⁹ "Final Workshop Report: Interim Emissions Performance Standard Program Framework, R.06-04-009, June 21-23, 2006."

¹⁷⁰ Jha, Alok and Terry Macalister (2008) "CO2 plan threatens new coal power plant." The Guardian. June 13, 2008.

¹⁷¹ Jowit, Juliette (2008) "Dirty coal power hit by Euro vote." The Guardian. October 7, 2008.

¹⁷² "Bill Signing Finalizes Year-Long Push for Clean Coal Portfolio Standard in Illinois." (2009) PR Newswire. January 12, 2009.

significant tax incentives for projects that capture at least 60% of their emissions.¹⁷³ The emission reduction executive orders in Florida could also be met with partial capture. A bill introduced in the Kansas legislature has proposed making 45% capture mandatory for new plants.¹⁷⁴ In proposed federal legislation, carbon credit incentives would be provided for achieving certain emissions rates that start out a moderate level and become stricter over time.¹⁷⁵

A leading industry group is also supporting an emissions performance standard. The United States Climate Action Partnership, USCAP, is an alliance of 30 prominent organizations including petroleum companies, utilities, energy technology providers, automotive manufacturers, and environmental groups. They have published recommendations for climate legislation that would establish an EPS of 1,100 lbs/MWh effective in 2015, and 800 lbs/MWh effective in 2020.¹⁷⁶ These are the same standards proposed by the most prominent current climate change legislation, the “American Clean Energy and Security Act of 2009.” These recent policy developments provide precedent and growing momentum for natural gas parity as an emissions standard.

¹⁷³ Souder, Elizabeth (2009) "Texas Legislature to revive clean coal debate." The Dallas Morning News. January 12, 2009.

¹⁷⁴ "Lawrence legislator angers many with his proposed energy bill."

¹⁷⁵ Climate Security Act of 2007. Low Carbon Economy Act of 2007.

¹⁷⁶ "A Blueprint for Legislative Action." (2009) United States Climate Action Partnership. January 2009.

5 TECHNOLOGY PROCESS DESCRIPTIONS

There are a variety of technologies to generate electricity from coal. The most established technology is that of a pulverized coal (PC) plant. The vast majority of all coal electricity in the United States is generated by about 600 PC plants across the country.¹⁷⁷ A more advanced technology is the integrated gasification combined cycle (IGCC) plant, of which there are four in commercial operation around the world.¹⁷⁸ Both of these types of plants are amenable to carbon capture and are discussed below. There are other power plant technologies, including oxy-firing, chemical looping combustion, and circulating fluidized bed combustion, that are also possibilities for electricity generation with carbon capture. However, these are either unsuitable for partial capture or still need development, and thus are not considered here as good candidates for near-term implementation of partial capture.

5.1 PULVERIZED COAL PLANTS

5.1.1 *Plant Basics*

Pulverized coal electricity generation involves combustion of coal that has been pulverized to very small particles with air in a boiler. The heat released generates steam, which is put through a steam turbine and used to power the electrical generator before being condensed and returned to the boiler. The flue gas that exits the boiler goes through selective catalytic reduction (SCR) to control the polluting oxides of nitrogen (NO_x), particulate removal by equipment such as an electrostatic precipitator (ESP) or baghouse, and flue gas desulfurization (FGD) to remove the pollutant sulfur dioxide (SO₂) before being released to the atmosphere through the stack. The figure below shows a simplified block diagram of this process.

¹⁷⁷ EIA-767 Data Files: Annual Steam-Electric Plant Operation and Design Data. (2005) Energy Information Administration. August 10, 2007.

¹⁷⁸ "The Future of Coal."

Figure 5-1. Simplified Process Flow Diagram of Pulverized Coal Power Plant¹⁷⁹

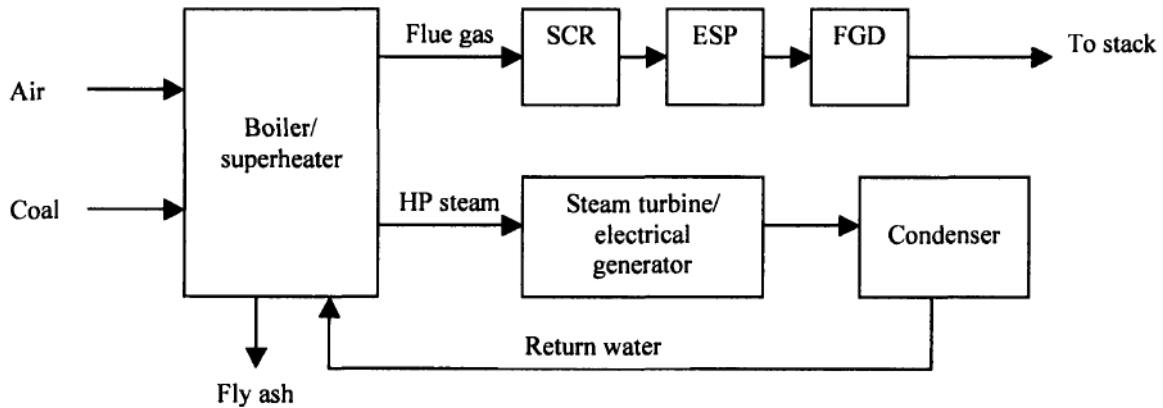

Pulverized coal plants are classified as subcritical, supercritical, or ultra-supercritical depending on the conditions of the steam generated in the boiler, which is a key determinant of the plant efficiency. Subcritical (SubC) plants typically operate with steam temperatures around 550°C and pressures under 22.0 MPa (often 16.5 MPa), resulting in efficiencies ranging from 33 – 37%.¹⁸⁰ Supercritical (SC) steam conditions are temperatures up to 565°C and pressures of about 24 MPa, achieving efficiencies of 37 – 40%.¹⁸¹ Ultra-supercritical (USC) plants generate steam temperatures greater than about 600°C with pressures greater than 31 MPa, which can reach efficiencies of 43 – 45%.¹⁸²

While high efficiency is desirable, the decision of what steam cycle to use also depends on total cost. Higher temperatures and pressures of the steam cycle lead to more expensive plants, so the desired efficiency must be weighed against project financing. In the United States, the low cost of coal has led developers to preferentially build subcritical plants¹⁸³, as the extra use of coal that results from lower efficiency is offset by the reduced total plant cost. Ultra-supercritical technology is not currently being widely utilized, as the associated steam conditions can cause

¹⁷⁹ Bohm, Mark (2006) Capture-Ready Power Plants - Options, Technologies and Economics. Engineering Systems Division, Massachusetts Institute of Technology. Cambridge, MA. June 2006.

¹⁸⁰ All efficiencies in this study are based on the higher heating value (HHV) of the fuel, which does not account for the latent heat of vaporization of water in the fuel.

¹⁸¹ "The Future of Coal."

¹⁸² Bohm

¹⁸³ Shuster

corrosion and material compatibility issues. Research is being directed at advancing materials to deal with these conditions, and goals of reaching temperatures greater than 700°C and pressures of 36.5 – 38.5 MPa could lead to efficiencies as high as 46%.¹⁸⁴

5.1.2 Post-Combustion Carbon Capture

The carbon contained in the fuel is converted to carbon dioxide during combustion in the boiler and becomes a component of the flue gas, where its concentration may be up to 15%.¹⁸⁵ The carbon dioxide is separated from the flue gas at the end of the flue gas clean-up process. This type of carbon capture is referred to as post-combustion because the carbon is separated after combustion, as shown in the figure below.

Figure 5-2. Simplified Process Flow Diagram of Pulverized Coal Plant with Carbon Capture¹⁸⁶

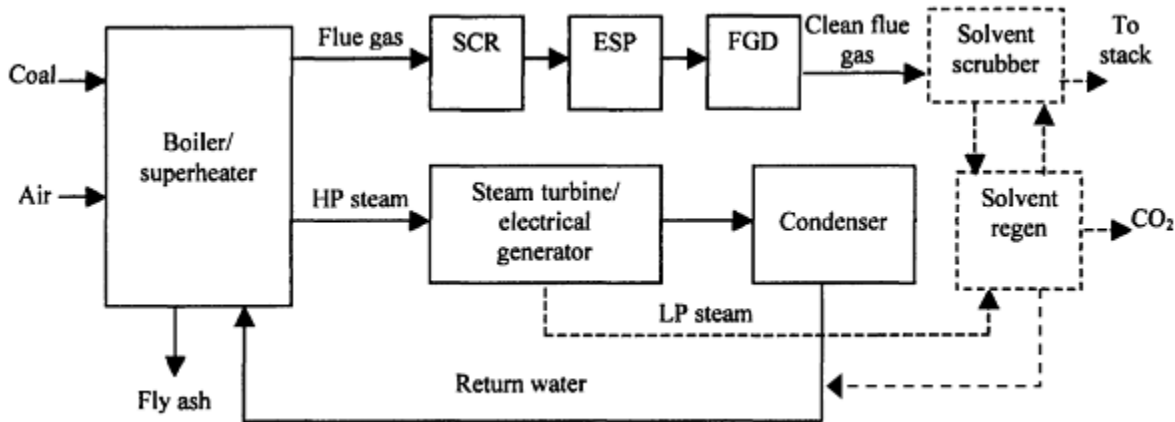

Because of the low concentration of the carbon dioxide, absorption into chemical solvents is the most appropriate currently-available separation medium. These solvents are typically aqueous amines, such as hindered amines or monoethanolamine (MEA).¹⁸⁷ The solvent may also contain additives to mitigate issues such as solvent degradation.

The carbon dioxide is separated from the flue gas and regenerated in a process shown in the figure below.

¹⁸⁴ "The Future of Coal."

¹⁸⁵ "IPCC Special Report on Carbon Dioxide Capture and Storage."

¹⁸⁶ Adapted from Bohm

¹⁸⁷ "The Future of Coal."

Figure 5-3. Process Diagram for Carbon Dioxide Separation Using Chemical Absorption¹⁸⁸

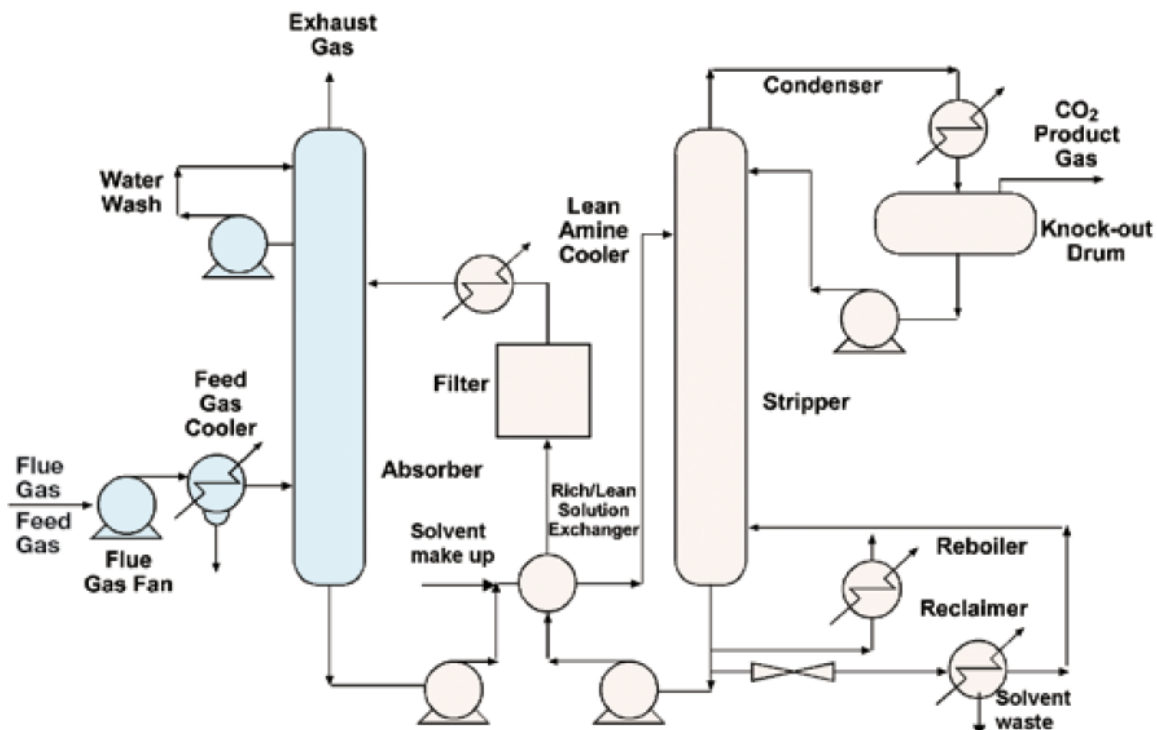

The carbon dioxide enters the absorber column where it contacts the chemical solvent. The carbon dioxide is absorbed into the solvent, and the “rich” solvent is transported to the stripper column. Heat is added to the solvent in the reboiler using low pressure (LP) steam extracted from the steam turbine. This heat releases the carbon dioxide from the solvent, producing a stream of carbon dioxide that is cooled, dried, and compressed. The carbon dioxide is now ready for injection or transportation in a pipeline. The regenerated solvent, now “lean,” is returned back to the absorber. The components of the flue gas not captured, mostly nitrogen and a small amount of carbon dioxide, are vented to the atmosphere. The system including the absorber, stripper, compressor, and associated equipment such as pumps and heat exchangers can be referred to as the carbon dioxide removal unit (CDR). The CDR and the carbon dioxide compressors are the main components added for post-combustion capture.

¹⁸⁸ "IPCC Special Report on Carbon Dioxide Capture and Storage."

5.2 INTEGRATED GASIFICATION COMBINED CYCLE PLANTS

5.2.1 Plant Basics

Integrated gasification combined cycle (IGCC) plants have an advanced design that shares few similarities with PC technology. The coal is gasified to produce a “syngas” which is burned in a combustion turbine, the waste heat from which is used to power a steam turbine. Both turbines are used to generate electricity, leading to the combined cycle designation. A simplified diagram of this is displayed below.

Figure 5-4. Simplified Process Flow Diagram of an IGCC Power Plant¹⁸⁹

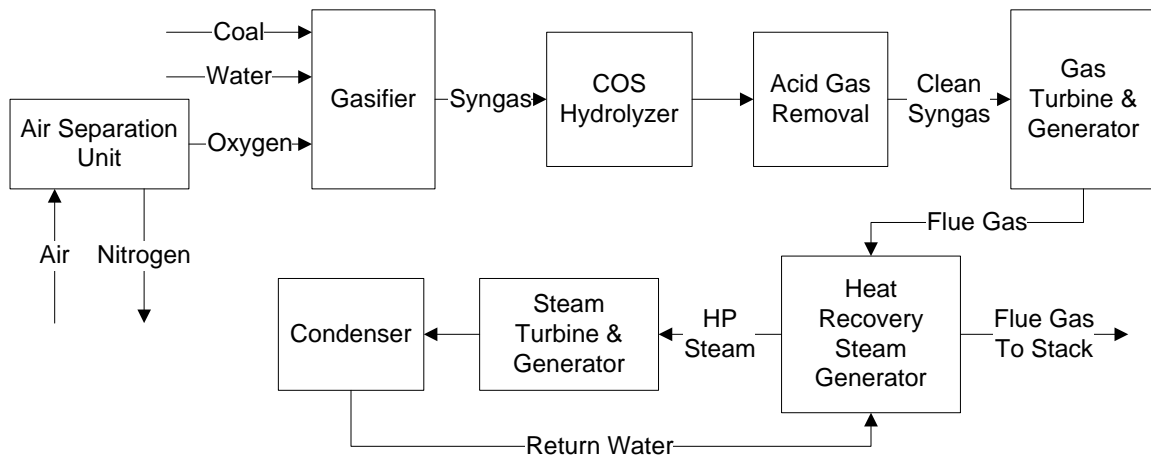

Air is taken into an air separation unit (ASU), which cryogenically separates the oxygen. The stream of oxygen, typically at 95% purity, is combined with finely-ground coal in a high temperature, high pressure gasifier. This partially oxidizes the coal, producing a syngas of predominantly hydrogen (H_2) and carbon monoxide (CO). The syngas is then cooled so that impurities and pollutants, including mercury, can be removed. In particular, compounds of sulfur, which would become the pollutant sulfur dioxide (SO_2) during combustion, must be removed in order to meet environmental regulations.¹⁹⁰ During gasification, most of the sulfur in

¹⁸⁹ Adapted from Bohm

¹⁹⁰ "Cost and Performance Baseline for Fossil Energy Plants." (2007) National Energy Technology Laboratory. August 1, 2007.

the fuel is converted to the acid gas hydrogen sulfide (H₂S), but some becomes carbonyl sulfide (COS) and must be converted to H₂S in a hydrolyzer.¹⁹¹

In the acid gas removal unit (AGR), the H₂S and some other trace impurities are separated from the syngas by absorption into a solvent. For non-capture plants, chemical, physical, or hybrid solvents can be used. Similar to the amine process for PC plants with CCS, chemical solvents absorb the acid gases in an absorber and are regenerated in a stripper column that drops the pressure and increases the temperature. At higher partial pressures of acid gas, physical solvents become preferable because the high partial pressure leads to adequate gas solubility in the solvent. Physical solvents are regenerated by flashing, or dropping the pressure such that the absorbed gases re-volatize and can be separated. Hybrid solvents are mixtures of various chemical and physical solvents, allowing some customization of factors such as regeneration energy requirements and selectivity for particular chemical species. The sulfur compounds separated by the AGR are converted to elemental sulfur, a commodity, using the Claus process.¹⁹²

The sulfur-free syngas exiting the AGR is burned in the gas turbine combustor to produce electricity. Natural gas combustion turbines are generally used, although the lower heat content of the pure syngas requires that a greater flow be used. This greater flow and the higher water content of the combustion products lead to concerns about overheating and turbine life. To address this, as well as NO_x formation, by reducing the firing temperature, or “derating” the turbine, steam or nitrogen can be sent through the turbine as well, although nitrogen, which is readily available from the ASU at high pressure, is generally preferred.¹⁹³ The extra mass flow of nitrogen through the turbine also contributes to electricity generation. The hot exhaust gas from the combustion turbine is used with a heat recovery steam generator (HRSG) to power a steam turbine, which also produces electricity in a generator, before being sent to the stack.

¹⁹¹ Holt, Neville A. H. (2001) Integrated Gasification Combined Cycle Power Plants. [Encyclopedia of Physical Science and Technology](#).

¹⁹² "Cost and Performance Baseline for Fossil Energy Plants."

¹⁹³ Ibid.

There is also integration of compressed air between the air compressor for the combustion turbine and the ASU, which reduces the compression needs in the ASU itself.

5.2.2 Pre-Combustion Carbon Capture

For an IGCC, the best way to separate the carbon is before combustion, referred to as pre-combustion capture. The diagram below shows a simplified IGCC with carbon capture.

Figure 5-5. Simplified Process Flow Diagram of an IGCC Power Plant with Carbon Capture¹⁹⁴

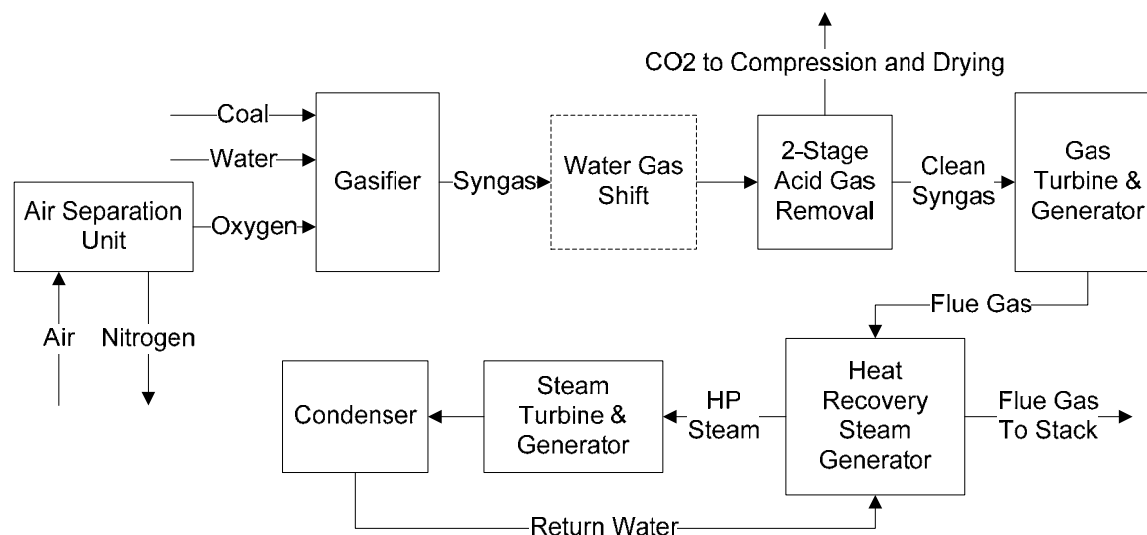

To accomplish this, syngas is sent to water gas shift (WGS) reactors. Steam is added to adjust the molar ratio of water to carbon monoxide to roughly 2:1, and the following catalyzed shift reaction takes place:

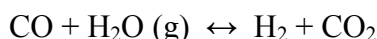

This shift reaction converts the carbon monoxide to carbon dioxide and hydrogen, and the majority of the carbon dioxide can be separated before the remaining gas is burned. The shift reaction also converts the COS to hydrogen sulfide, obviating the need for the COS hydrolyzer. It is now generally accepted that the shift is preferably performed upstream of the AGR; a “sour shift” is performed. While this results in more stringent metallurgical requirements for some equipment, it allows the carbon dioxide to be captured in a modified integrated AGR.¹⁹⁵ A two-

¹⁹⁴ Adapted from Bohm

¹⁹⁵ "Cost and Performance Baseline for Fossil Energy Plants."

stage AGR is used, generally with the physical solvent Selexol, which flows countercurrent to the syngas. The syngas enters the first absorber where the hydrogen sulfide is preferentially absorbed into a portion of already carbon dioxide-rich solvent, then the syngas is sent to a second absorber where the carbon dioxide is absorbed into freshly regenerated solvent. After exiting the AGR, the clean syngas, now predominantly hydrogen, is sent to the gas turbine combustor. The solvent from the first absorber, loaded with hydrogen sulfide and some of the carbon dioxide, is put through a stripper and the resulting gas stream is sent to the Claus unit.

The solvent that is rich in carbon dioxide, but that did not enter the hydrogen sulfide absorber, is flashed to regenerate the solvent and produce streams of carbon dioxide. A series of flashes are used at decreasing pressures so that some pressure is maintained in the resulting carbon dioxide streams, thereby minimizing compression demands.¹⁹⁶ The first flash, at the highest pressure, will release volatile impurities in addition to carbon dioxide, so this stream should be recycled to the absorber columns. Impurities in the other flash streams must also be addressed to ensure that pipeline or injection specifications for the carbon dioxide are met.¹⁹⁷ The remaining carbon dioxide streams are dried and incorporated into the compressor system at their respective pressures.

¹⁹⁶ Ibid.

¹⁹⁷ Schoff, Ron (2008) Personal Communication. October 8, 2008.

6 IMPLEMENTATION OF POST-COMBUSTION CAPTURE

6.1 FULL-CAPTURE CCS

A pulverized coal plant designed for full capture is technologically different from a non-capture plant. In order to apply the processes described in Chapter 5, new equipment must be added and the CCS system must be integrated with the base power plant. This has important impacts on the performance and economics of the plant.

6.1.1 *Equipment and Integration*

The use of full capture means that additional or modified equipment and integration will be necessary. The major distinctions between full capture and no capture are listed in Table 6-1 and discussed below.

Table 6-1. Equipment and Integration Impacts of Full Capture at a PC Plant

Additional flue gas desulfurization
Multiple parallel trains of carbon dioxide separation equipment
Carbon dioxide compressors, possibly multiple trains
Integration of LP steam from steam turbine with CDR stripper
Non-standard or modified turbine design
Expanded cooling water system

Because post-combustion capture is essentially an “end-of-pipe” treatment, the equipment in the flue gas path from the boiler to the flue gas desulfurizer is essentially the same. A typical FGD can remove 98% of the sulfur dioxide in the flue gas; this sufficiently meets environmental regulations of about 30 ppmv, depending on the coal.¹⁹⁸ However, the concentration of the sulfur dioxide in the flue gas must be 10 ppmv or lower to minimize the formation of heat-stable solids during contact with the amine solvent, so the flue gas must be scrubbed beyond environmental limits. To accomplish this, an ultra-high efficiency FGD can be used, or a

¹⁹⁸ "Cost and Performance Baseline for Fossil Energy Plants."

“polishing unit” that scrubs the flue gas with sodium hydroxide can be added prior to the carbon dioxide removal unit.¹⁹⁹

After sulfur dioxide removal, the flue gas is sent to the carbon dioxide removal unit (CDR). For a commercial-scale power plant, the volumetric flowrate of flue gas is typically too great to be processed by a single absorber/stripper train, as the resulting column sizes would exceed feasible manufacturing and transportation capabilities. As a result, two or more parallel trains of absorber/stripper are used. Parallel compressors may be used, or the carbon dioxide streams may be combined for one large compressor. In addition to the absorber, stripper, and compressor, a number of flue gas blowers, pumps and heat exchangers will be necessary. Because this system and configuration are not commonly used in industry²⁰⁰, this can be referred to as a technology “step-out.”

To maximize efficiency, the CDR must be integrated with the base plant. The most important point of integration regards use of steam in the reboiler of the stripper for solvent regeneration. While a separate steam generator can be used, it is preferable to extract steam from the steam turbine. The steam requirements will vary by solvent and some design parameters. Typical values of regeneration energy for the common solvent Econamine FG Plus may be 1395-1530 Btu/lb carbon dioxide.²⁰¹ To meet the steam conditions required for stripping the solvent, the steam is extracted either from the crossover pipe that transports steam from the intermediate pressure (IP) section of the steam turbine to the low pressure (LP) section, or from extraction ports within the LP section itself. It may be required to extract 40-50% of this steam flow²⁰², but potentially up to 79% if the regeneration energy of the solvent is very high.²⁰³ Because

¹⁹⁹ Ibid.

²⁰⁰ "Technologies to Reduce or Capture and Store Carbon Dioxide Emissions." (2007) The National Coal Council. June 2007.

²⁰¹ "Cost and Performance Baseline for Fossil Energy Plants."

²⁰² "CO2 Capture Ready Plants." (2007) IEA Greenhouse Gas R&D Programme. May 2007.

²⁰³ "Engineering Feasibility and Economics of CO2 Capture on an Existing Coal-Fired Power Plant: Final Report." (2001) Alstom Power Inc., ABB Lummus Global Inc., Alstom Power Environmental Systems, American Electric Power.

extraction locations are constrained by practical aspects of turbine operation, the extracted steam may not be optimized to the reboiler needs, in which case the steam should be integrated into another process to ensure that energy is not wasted.

Extraction of steam from the steam turbine has an important impact. Because the energy of the extracted steam is removed for use in the stripper, the turbine will generate less electricity. The relationship between steam extraction and power loss is shown to be linear.²⁰⁴ Because the quantity of steam extracted is substantial, the energy penalty associated with steam extraction is as well (discussed further below). Much research is focused on reducing the energy requirement of the stripper with the objective of reducing the steam demand and associated energy penalty.

Extraction of the steam may require a non-standard or modified turbine design. Standard turbine designs generally assume a roughly constant flowrate of steam through the high pressure, intermediate pressure, and low pressure sections of the turbine. If significant steam is extracted from a standard design, a number of concerns arise. There are limitations to the amount of steam that can be extracted while maintaining turbine function, as some steam at a sufficient pressure must flow through the turbine to keep the turbine blades cool. Also, turbines are designed to operate most efficiently at a specified volumetric flowrate to ensure proper angle alignment of the flow with the turbine blades. Reduction of the flowrate through the LP turbine can result in sub-optimal operation, decreasing its efficiency and creating a secondary energy penalty. If a single-flow LP turbine is used, the forces throughout the interconnected turbine sections will be out of balance, possibly creating problems in anchoring the turbine. If the LP section is double-flow, however, as is likely for a commercial-scale coal plant, the forces will self-correct. The question of whether to use a standard turbine operating at off-design conditions or a modified turbine that can accommodate its new design point will be largely economic and not technical.²⁰⁵

²⁰⁴ Roberts, C. A., J. R. Gibbons, et al. (2004) Potential for Improvement In Power Generation with Post-Combustion Capture of CO₂. *7th International Conference on Greenhouse Gas Control Technologies*. Vancouver, BC. September 5-9, 2004.; Carbon Dioxide Capture from Existing Coal-Fired Power Plants. (2006) National Energy Technology Laboratory, U.S. Department of Energy. ; Horazak, Dennis and Robert Shannon (2009) Personal Communication. March 10, 2009.

²⁰⁵ Horazak and Shannon

If a turbine is designed with steam extraction in mind, although reduced output will still occur, many of these other concerns can be mitigated. Due to industry's lack of familiarity with this degree of steam extraction and non-standard turbine designs, this is referred to as a technology step-out.

The water systems are also affected by capture. Carbon capture increases the demand for water, possibly by over 100%. This is reflected in a larger cooling water system, including larger cooling water pumps and cooling towers, and the system must be integrated into the CDR.

6.1.2 *Performance*

The use of carbon capture at a coal-fired power plant has impacts on the performance of the plant, including gross output, efficiency, auxiliary power use, and demand for consumables. As discussed above, extraction of steam from the steam turbine both reduces output and impairs turbine efficiency. Extraction of steam can result in as much as a 28% reduction in the gross electrical output of the steam turbine generator.²⁰⁶ There is also considerable auxiliary energy required to run the carbon dioxide compressors and, to a smaller extent, the pumps and blowers associated with capture; these can represent over 50% of the total auxiliary load in a capture plant.²⁰⁷ Overall, carbon capture reduces the net output and efficiency of the power plant by roughly 24-30%, and possibly more for a subcritical plant.²⁰⁸ Approximately 1/3 of that penalty is a result of additional auxiliary energy requirements, and 2/3 is due to reduced gross output from the turbine generator.²⁰⁹ Emissions of criteria air pollutants will generally be lower, as the carbon capture process will further reduce their levels in the flue gas. In addition to the higher water demand, capture also creates the need for an amine solvent and possibly a few other additional consumables such as sodium hydroxide for a sulfur dioxide polishing unit.

²⁰⁶ "Engineering Feasibility and Economics of CO₂ Capture on an Existing Coal-Fired Power Plant: Final Report."

²⁰⁷ "Cost and Performance Baseline for Fossil Energy Plants."

²⁰⁸ "The Future of Coal." ; "Cost and Performance Baseline for Fossil Energy Plants."

²⁰⁹ Freund, Paul and John Davison (2002) General Overview of Costs. IPCC Workshop on Carbon Dioxide Capture and Storage. Geneva, Switzerland. April 17-20, 2002.

6.1.3 Economics

The equipment, integration, and performance issues associated with capture affect cost. The increase in total capital cost and unit (per net kilowatt) capital cost resulting from the additional equipment needs can be 60% to greater than 80%.²¹⁰ Typical values for the cost of avoided carbon dioxide emissions are on the order of \$70/ton. Because of the wide range of assumptions and design conditions used in design studies, there is a corresponding wide range of reported cost numbers that are not necessarily easily compared.

6.2 PROSPECTS FOR PARTIAL CAPTURE

If full capture is not required, the impacts on the plant can be mitigated. The advantages of partial capture over full capture are summarized in Table 6-2 and discussed below.

Table 6-2. Benefits of Partial Capture vs. Full Capture for Pulverized Coal Plants²¹¹

Technological Distinctions	Associated Performance and Economic Benefits
Reduced number, size of equipment	Reduced capital cost
Reduced and optimized steam extraction	Improved plant output and efficiency
Reduced auxiliary load	Improved plant output
Potential for temporary bypass	Greater dispatch to the grid during peak electricity demand
Reduced consumables and water use	Lower operational cost
Selective flue gas cleanup	Avoided unnecessary costs

Partial capture is accomplished by bypassing a portion of flue gas around the CDR; this is preferred over adjusting the performance of the absorber column.²¹² The number of trains and column sizes needed for the CDR is determined by the volumetric flowrate of the flue gas undergoing carbon capture. If lower capture rates are desired, smaller pieces of equipment can be used for the absorber, stripper, and compressor. If the capture rate is low enough, a single train can be used instead of parallel trains. The associated pumps, heat exchangers, and other

²¹⁰ "The Future of Coal." ; "Cost and Performance Baseline for Fossil Energy Plants."

²¹¹ Hildebrand, A.N. and H.J. Herzog (2008) Optimization of Carbon Capture Percentage for Technical and Economic Impact of Near-Term CCS Implementation at Coal-Fired Power Plants. 9th International Conference on Greenhouse Gas Technologies. Washington, DC. November 18, 2008.

²¹² Carbon Dioxide Capture from Existing Coal-Fired Power Plants.

equipment associated with the CDR can be reduced in number or size as well. Because of the reduced scale of these systems, the technology step-out for partial capture is less extensive.

If lower capture rates are used, a less extensive step-out is needed for the turbine as well. Less steam will need to be extracted from the steam turbine. Compared to full capture, this has the effect of preserving greater turbine output as well as improving the scope for optimizing the extraction of the steam. If a standard turbine design is used, the impact on turbine efficiency will be mitigated. The cause for using a non-standard design will also diminish as the capture rate is reduced. The auxiliary energy demand associated with running the pumps, blowers, and compressors will also be reduced.

Another valuable aspect of partial capture for PC plants is that the equipment to bypass the CDR is already installed. If sized properly, this can allow the plant operators to dynamically adjust the capture rate by adjusting the bypass ratio. A plant's electricity is most valuable when electrical demand is high. This means that the monetary penalty associated with capture is also greatest during peak demand. If the plant can reduce capture during these times, the overall plant economics can be improved. Designing the capture system for a greater capture rate than that desired can ensure that overall capture specifications will be met despite dynamic operation.

Water demands and capture-related consumables, like the solvent, will also be not as great as in the full-capture case. All of these aspects will improve the plant output, efficiency, and economics. Since the portion of flue gas bypassed around the CDR will not be contacting the solvent, it is unnecessary to reduce the sulfur dioxide concentration to levels beyond environmental specifications for this stream. Avoiding this will result in savings of equipment cost, auxiliary load, and consumables demand.

6.3 CONSIDERATIONS FOR RETROFITS

CCS can be relatively easily retrofitted to pulverized coal plants because it does not necessitate much modification of the base plant. However, the impacts of carbon capture on the plant discussed here assume that the plant is originally designed to incorporate capture and that the CDR is optimally integrated with the base plant. If capture is retrofit to an existing plant, many

of the opportunities for integration may not be available. This will result in an even greater energy penalty. To extract sufficient steam from the turbine, for the reasons discussed above it may be necessary to modify the LP section of the turbine or completely replace it with a non-standard design. Generally, the impacts associated with capture are exacerbated when added as a retrofit. In this situation, then, the mitigation of impacts provided by partial capture has added importance. For plants that are considerably older and less efficient, it may make sense to repower the plant, meaning replacement and upgrading of much of the equipment. Compared to a straight retrofit, adding carbon capture as part of repowering could allow better integration and improved performance.

7 IMPLEMENTATION OF PRE-COMBUSTION CAPTURE

7.1 FULL-CAPTURE CCS

To accomplish pre-combustion capture of 90% of carbon dioxide emissions from an integrated gasification combined cycle plant, there are a number of important distinctions from a non-capture plant. The equipment installed and integration in the plant is different, which has important impacts on the plant's performance and economics.

7.1.1 *Equipment and Integration*

The equipment and integration for a capture plant are different than from a non-capture plant. The major differences are listed in Table 7-1 and discussed below.

Table 7-1. Equipment and Integration Impacts of Full Capture at an IGCC Plant

2- or 3-stage water gas shift reactors and associated equipment
Integration of steam for the shift reaction
Greater capacity of equipment and piping between shift and AGR
2-stage AGR including carbon dioxide absorber and flash regeneration system
Carbon dioxide compressors, possibly multiple trains
Hydrogen turbine or additional turbine derating
Non-standard matches of equipment sizes for ASU, gasifier, and turbine

The carbon monoxide in the syngas must be shifted to carbon dioxide so that it can be separated from the gas prior to combustion. This requires the installation of water gas shift reactors. To get sufficient conversion of the carbon monoxide, two shift reactors in series must be used. In some cases, depending on the gasifier parameters, a third stage of shift may be necessary.²¹³ Multiple, usually two, parallel trains are necessary to accommodate the volumetric flow of the syngas. Coolers must also be used between shift stages to maintain suitable temperatures for the shift reaction and the catalyst, and other auxiliary equipment like pumps and blowers will be required. Steam is also needed for the shift reaction in a molar ratio of 2:1 with the carbon monoxide. The use of a slurry coal feed or water quench provides some of this steam; the

²¹³ "Cost and Performance Baseline for Fossil Energy Plants."

remainder is combined with the syngas prior to entering the first reactor. The interstage cooler between the shift stages can be used to raise some of this steam, but the rest must be obtained from elsewhere in the plant. The shift reaction also results in a greater flowrate between the shift reactors and the AGR, so pipe and equipment capacities must be increased. The shift reactors represent a technology “step-out” because they are not commonly used in the power industry.

The carbon dioxide in the shifted syngas is absorbed and regenerated in the acid gas removal unit (AGR). This is considered to be a relatively mature technology for industry.²¹⁴ For full capture, the AGR must include separate columns for removal of the hydrogen sulfide and the carbon dioxide. Flash drums must also be used to release the carbon dioxide from the solvent. A cryogenic separation or recycle system may also be necessary to ensure that the carbon dioxide is clean enough to meet pipeline or injection specifications.²¹⁵ The use of carbon capture will also necessitate more pumps, blowers, and other associated equipment, in addition to large carbon dioxide compressors.

Because the syngas exiting the AGR is now primarily hydrogen, and the combustion products will have a higher water content, there are additional considerations for burning it in the syngas turbine, leading to a technology step-out. It is possible that a hydrogen combustion turbine must be used, and these are currently in development.²¹⁶ If a standard turbine is to be used, this will require derating it (reducing the firing temperature) more than in the non-capture plant to both preserve turbine life and reduce NO_x formation. This can be achieved with greater dilution with nitrogen, which will also help preserve turbine output. While much nitrogen from the ASU is already available, this nitrogen may not be sufficient, so steam injection or humidification may have to be considered. In the capture case, it is also unlikely that integration of compressed air between the combustion turbine compressor and the ASU is worthwhile.²¹⁷

²¹⁴ "Technologies to Reduce or Capture and Store Carbon Dioxide Emissions."

²¹⁵ Schoff

²¹⁶ "Advanced Coal Power Systems with CO₂ Capture: EPRI's *CoalFleet for Tomorrow* Vision." (2008) Electric Power Research Institute. Interim Report, September 2008.

²¹⁷ "Cost and Performance Baseline for Fossil Energy Plants."

Furthermore, carbon capture will require a non-standard overall IGCC design. Much of the equipment in power plants comes in standard discrete sizes. IGCC plants are generally designed using certain pairings of the air separation unit, gasifier, and combustion turbine so that they are sized appropriately with respect to one another. However, capture modifies the volumes being processed through the equipment after the shift reactors. For a standard design, then, the gasifier and air separation unit will be undersized compared to the turbine, meaning that they will not produce enough shifted syngas to fill the turbine correctly. For this reason, non-standard pairings of these pieces of equipment will be necessary, representing another technology step-out.

7.1.2 Performance

The efficiency and net output of the plant are adversely affected by carbon capture. The use of steam for the shift reaction results in an energy penalty because that steam could be used in the steam turbine or elsewhere in the plant for heat integration. The water gas shift reaction itself decreases the heating value of the syngas by approximately 10%, depending on the gasifier conditions.²¹⁸ While nitrogen injection in the combustion turbine can help maintain turbine output, this is limited by turbine operational constraints.²¹⁹ Reduced integration of compressed air between the ASU and the combustion turbine will result in lower efficiency. Carbon capture also increases the auxiliary power requirements of the plant. Additional power will be needed for much of the equipment associated with the water gas shift reactors, the carbon dioxide recovery portion of the acid gas removal unit, and the carbon dioxide compressors, although compression energy necessary for an IGCC is less than that for a PC because of already higher pressures. All of these issues impair net output and efficiency, which can be reduced by roughly 15-25%.²²⁰ The demands for consumables and water increase with capture. Water demand can increase by as much as 74%.²²¹ A solvent appropriate for carbon capture, such as Selexol, must be used, and a greater quantity will be needed with capture than without. Catalyst for the water gas shift reaction will also be necessary. In general, emissions of criteria air pollutants from a

²¹⁸ "Advanced Coal Power Systems with CO₂ Capture: EPRI's *CoalFleet for Tomorrow* Vision."

²¹⁹ "The Future of Coal."

²²⁰ Ibid.; "Cost and Performance Baseline for Fossil Energy Plants."

²²¹ "Cost and Performance Baseline for Fossil Energy Plants."

plant with capture will be lower because the carbon capture processes will further reduce their presence in the syngas.

7.1.3 Economics

The base (non-capture) IGCC plant may be 8%-47% more expensive than a base PC plant, which is a reflection of the greater amount of equipment necessary for an IGCC.²²² An IGCC with carbon capture will be more expensive than one without capture. The total capital cost may increase by up to 17%, while the unit (per net kilowatt) total capital cost may increase by around 36%.²²³ The cost of avoided emissions from an IGCC plant is in the range of \$30-\$40/ton as compared to a non-capture IGCC plant²²⁴, but these numbers can be at least 25% higher if a PC plant is used as the reference.²²⁵ These numbers are quite low compared to those for pulverized coal, but it is necessary to note that this is partly due to the much higher total cost for the IGCC plant, of which the capture equipment is a smaller component. Additionally, there is currently little faith in cost numbers for IGCC plants, so plant cost values should be viewed skeptically. This is due to recent increases in commodity and capital costs, as well as the fact that there is little implementation experience with IGCC with which to judge actual plant costs. The wide range of design specifications, conditions, and gasifier technologies also contribute to uncertainty in these costs.

7.2 PROSPECTS FOR PARTIAL CAPTURE

The amount of carbon captured from the syngas is largely determined by the extent of carbon monoxide conversion in the shift reactors and the carbon dioxide removal efficiency of the absorber of the AGR. Theoretically, the capture rate could be controlled by modifying the extent of shift reaction, bypassing some of the syngas around the shift reactor, and/or modifying the removal efficiency of the AGR.

²²² "The Future of Coal." ; "Cost and Performance Baseline for Fossil Energy Plants."

²²³ "Cost and Performance Baseline for Fossil Energy Plants."

²²⁴ Ibid.

²²⁵ Hamilton and Herzog

It is now expected that the AGR would be operated the same regardless of desired capture rate. A typical two-stage Selexol will remove up to 95% of the carbon dioxide in the syngas²²⁶, although capture greater than 97% is possible.²²⁷ It is also possible that some carbon capture can be achieved without expanding the AGR into two stages, but design studies on this option are yet to be released. Bypassing some of the syngas around the shift reactors would likely necessitate a COS hydrolyzer for that bypass stream, and the practicality of this option is not yet determined. This leaves modification of the extent of shift reaction as the primary method of achieving a specific capture rate.

For most gasifier designs, conversion of about 96% of the carbon monoxide is achieved by using two stages of shift. The installation of only a single stage of shift will result in a moderate conversion, and the resulting carbon dioxide can then be removed in the AGR. Some carbon dioxide is generated in the gasifier itself and can be removed without a shift reactor at all. This is referred to as “skimming.” The overall carbon capture achieved depends on the gasifier, shift specifications, and AGR. Various numbers for these options have been reported. Skimming may result in capture up to 25%, while 50-80% capture may be achieved with only a single stage shift.²²⁸ While installing discrete numbers of pieces of equipment will achieve distinct capture rates, the capture rate can be further tailored by controlling the extent of the shift reaction through the steam ratio and catalyst, although this option is still being researched.

There are important advantages of partial capture over full capture for an IGCC, and these are summarized in the table below.

²²⁶ "Cost and Performance Baseline for Fossil Energy Plants."

²²⁷ Holbrook, David (2009) "RE: Selexol for CO2 Capture." Personal Communication. February 16, 2009.

²²⁸ Hildebrand and Herzog.

Table 7-2. Benefits of Partial Capture vs. Full Capture for IGCC Plants²²⁹

Technological Distinctions	Associated Performance and Economic Benefits
Reduced number, size of equipment	Reduced capital cost
Reduced auxiliary load	Improved plant output
Reduced consumables and water use	Lower operational cost
Reduced steam consumption	Improved electrical output or heat integration
Reduced or avoided turbine derating	Improved plant output and efficiency

Less equipment will be needed if the shift is reduced to one stage or avoided altogether, reducing the severity of the technological step-out. Lower capture rates may also reduce the necessary investment in the AGR. Expansion into two stages may be unnecessary, or it may be possible to use smaller or only one train of the carbon dioxide absorber column, flash regenerators, and compressors. At lower capture rates, the post-separation equipment, such as for any additional clean-up and the carbon dioxide compressor, can also be smaller.

These options will reduce the capital cost associated with carbon capture. The auxiliary power requirements for capture will also be reduced, especially for compression. Demand for water and consumables will also be reduced. Steam not needed for the shift can be used for heat integration or in the steam turbine, improving plant efficiency.

In partial capture, the syngas will also have retained some of the carbon monoxide. This means that the step-out of combustion turbine derating will be mitigated or the need for a hydrogen turbine can be avoided. At lower capture rates, the size mismatch between the standard pairings of the ASU, gasifier, and turbine may also be less problematic. All of these issues make partial capture easier to implement than full capture.

7.3 CONSIDERATIONS FOR RETROFITS

Although there are only a few operating IGCCs in the world today, it is feasible that an IGCC plant, even if built in the future, would some day be retrofitted to include carbon capture. To retrofit for full capture, the nature of pre-combustion capture requires that the shift reactors and the expanded AGR are incorporated into the existing syngas path. Without planning for this

²²⁹ Ibid.

during original construction, this may be prohibitively difficult. Furthermore, if a sour shift is used, much of the equipment between the shift reactors and the AGR will have to be replaced to handle the additional flow. This is not a problem if a sweet shift, or a shift after sulfur removal, is used, but then the steam generated in the gasifier or by a quench is lost during the syngas clean-up, and so all of the shift steam must be separately generated and added prior to the shift. The reduction in syngas that results from the shift and carbon dioxide separation will mean that the syngas turbine will not be fully loaded. In other words, the gasifier and air separation unit will be undersized compared to the syngas turbine, leading to additional inefficiencies. This may require replacement or modification of the turbine, or expansion of the ASU and gasifier capacities. It will also be necessary to derate the turbine, requiring either integration of nitrogen from the ASU, steam injection, or humidification. All of these things will have even greater adverse consequences on plant performance than a plant originally build to include capture. For these reasons, it is expected that retrofitting for partial capture is more feasible than retrofitting for full capture. By reducing the capture rate, the modifications necessary in the syngas pathway will be mitigated, as will the associated impacts on plant performance and efficiency.

8 PC PERFORMANCE AND ECONOMIC MODELING

8.1 EVALUATION METHODOLOGY

To investigate the impact of capture percentage on plant performance and economics, spreadsheet models were developed to quantitatively assess the relevant technical and economic aspects of partial capture. A model was developed for a greenfield (new build, as opposed to retrofit) supercritical (SC) PC plant. It is based on data from the National Energy Technology Laboratory's (NETL) "Cost and Performance Baseline for Fossil Energy Plants." This report was selected because it contains the most complete and recent set of data on which to base such models.

As discussed in Chapter 3, there have been dramatic escalations in commodities and materials costs that have impacted the cost of plants, even since the NETL report was published. Also, the current economic downturn has an as yet unknown impact on costs. This means that there is great uncertainty regarding the *absolute* costs of these plants. However, since the interest of this work is to examine the *relative* costs as a function of capture percentage, the NETL report provides an appropriate basis. To highlight these relative costs, the costs are normalized to the cost of the non-capture case.

From the NETL study, the supercritical pulverized coal model uses the data from cases 11 and 12. Relationships between process parameters and variables were obtained from these data. The partial capture model is based on the non-capture case, case 11, and the model "adds" capture to this base plant. Whereas the NETL report held net plant output constant by increasing the coal feed for the full-capture plant to compensate for the parasitic energy demands of capture, the models developed here use constant coal feed, and experience reduced gross output as a result of capture. This was done so that many of the equipment sizes and costs would be independent of capture percentage. An example of relevant aspects of the supercritical model is presented in Appendix A.

For a desired capture percentage, new flowrates and stream compositions are calculated. Equipment sizes for the CDR (absorber, stripper, and their peripherals), carbon dioxide compressors, condenser, steam turbine, cooling towers, and circulating water pumps are computed using flowrates, average excess capacity, and the number of trains. It is assumed that for the CDR and compressor, two equal-size parallel trains would be necessary for capture rates beyond 45% capture, or half of full capture. Up to that point, a single train of absorber/stripper/compressor is used. This represents a technological “breakpoint” where a discrete change in the process or equipment is necessary. Capital costs for the newly-sized equipment are computed using Equation 1, below.

$$Cost_B = Cost_A \left(\frac{Capacity_B}{Capacity_A} \right)^M \quad \text{Eq. 1}$$

The data from multiple PC cases of the NETL report are used to calculate capacity-cost exponents (M), and these exponents are used to scale the cost for the partial capture case. These cost numbers allow total plant costs to be computed.

The relationship between capture percentage (and thus extraction steam) and turbine output is assumed to be linear, as stated in Chapter 6. Auxiliary power demands for the CDR auxiliaries, compressor, circulating water pumps, cooling tower fans, condensate pumps, and transformer loss are computed. These allow the net power, efficiency, and heat rate to be calculated. Demands for consumables such as the MEA solvent (Econamine FG Plus), limestone, and water are approximated and used to estimate annual operating and maintenance (O&M) costs.

The cost of electricity (COE) contributions from capital costs, fuel, fixed and variable O&M are calculated using low-risk factors. While the full-capture cases in the NETL study use high-risk factors²³⁰, the low-risk factors are used here for consistency across capture rates. The COEs are used to compute the cost of avoided emissions (mitigation cost) and the cost of captured emissions. The costs of avoided emissions and captured emissions in \$/ton (short, not metric, ton) are calculated as compared to a non-capture reference plant. A supercritical PC plant was chosen as the reference plant for all cases including IGCC. Because pulverized coal technology

²³⁰ "Cost and Performance Baseline for Fossil Energy Plants."

is traditionally employed in the United States, this provides a more accurate representation of these costs compared to the status-quo.

The models developed to investigate partial capture are specific to the original NETL study design. There are a number of key parameters that are likely to vary among designs, as the technology develops, the CCS industry grows, or the economic situation changes. For this reason, it is important to test the sensitivity of the results to these parameters.

These sensitivities include the capture percentage at which the second train of absorber/stripper must be added, and the capture percentage at which a second parallel compressor is needed. As discussed in Chapter 2, the choice of investment for near-term baseload electricity is likely to be coal versus natural gas. This choice will be influenced by the relative prices of these feedstocks. Thus, it is informative to consider the sensitivity of the partial capture model results to the price of coal.

The level of capture that would reduce emissions to the level of emissions from natural gas is of particular interest, as discussed in Chapter 4. To examine this, the economic results for a natural gas combined cycle (NGCC) plant were obtained from the NETL “Cost and Performance Baseline for Fossil Energy Plants” report. This plant achieves a carbon dioxide emissions rate of 797 lbs/MWh.²³¹ The model was used to identify the capture percentage which achieves the same emissions rate. The economic results are then used to compare the cost of electricity from a natural gas plant and a coal plant with comparable emissions. Because this will be partly dependent on the relative prices of the fuels, this analysis is performed as a sensitivity to the prices of coal and natural gas.

8.2 RESULTS

The objective of this study is to explore the relationship between capture percentage and various economic and performance measures, as lower capture levels may reduce the technical and economic challenges faced by the first movers of this technology. Due to the uncertainty

²³¹ Ibid.

regarding the absolute cost numbers, most cost numbers presented here are normalized with respect to the non-capture case. The metrics of the price of carbon (\$/ton avoided and \$/ton captured) are computed as a comparison to a reference non-capture plant, so normalization is unnecessary.

The impact of carbon capture percentage on gross and net power output is shown in Figure 8-1.

Figure 8-1. Plant Output Dependency on Capture Percentage for SC PC Model

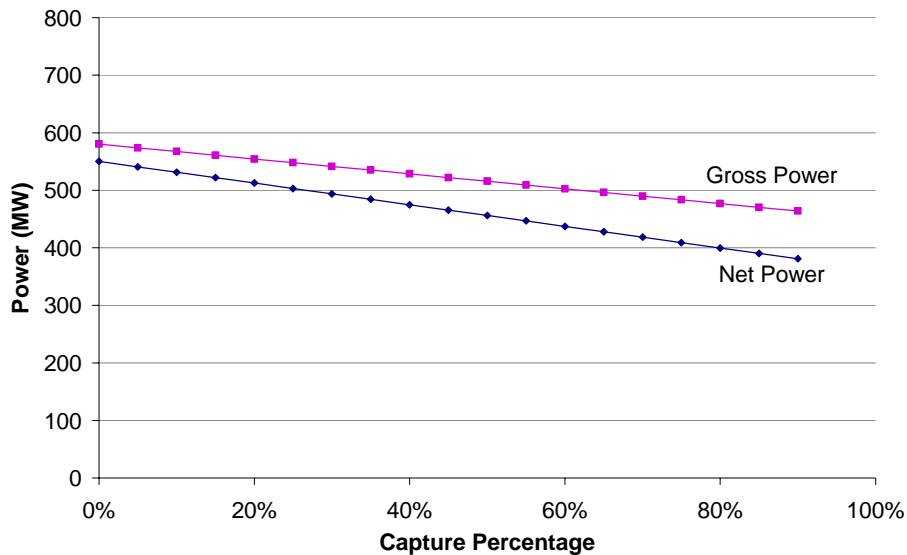

Gross power output decreases with increased capture as a result of the steam extraction from the steam turbine for the purpose of solvent regeneration, resulting in a linear relationship between gross power and capture percentage. The difference between gross and net power increases due to the additional parasitic electricity load of the capture process, including the CO₂ compressors. As the increase in auxiliary demand is proportional to the capture percentage, the net power is also linear with respect to capture.

Figure 8-2 shows the efficiency and heat rate (on a higher heating value, HHV, basis) with respect to capture percentage.

Figure 8-2. Plant Performance Dependency on Capture Percentage for SC PC Model

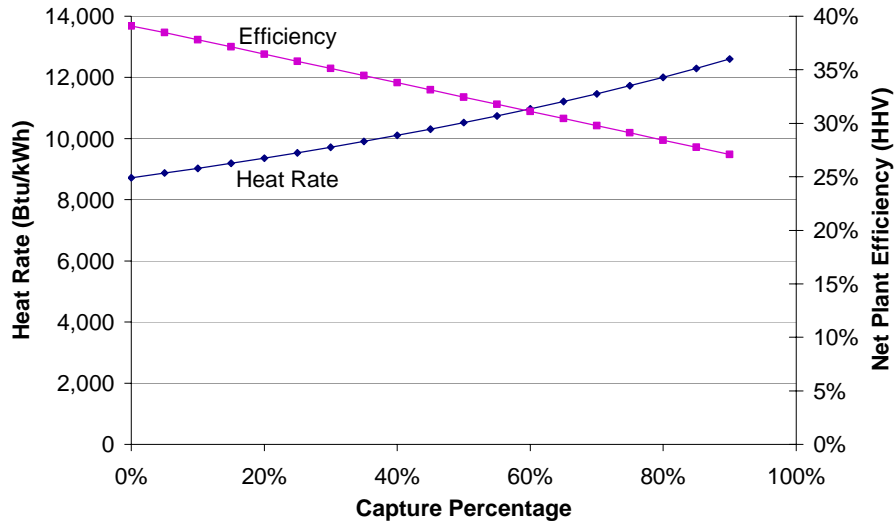

As shown in Figure 8-2, the heat rate goes from about 8,700 Btu/kWh, an efficiency of 39%, to about 12,600 Btu/kWh, an efficiency of 27%. These are both roughly linear with respect to capture percentage.

Figure 8-3 shows the total capital cost and the capital cost of the capture equipment as a function of capture percentage. The carbon dioxide capture equipment cost includes the carbon dioxide removal unit (CDR, including the related pumps, heat exchangers, etc.) and the carbon dioxide compressors. The jump in the curves between 45% and 50% capture is a result of going from one large train of CDR and compressor to two equal-sized (but smaller) trains.

Figure 8-3. Capital Cost Dependency on Capture Percentage for SC PC Model

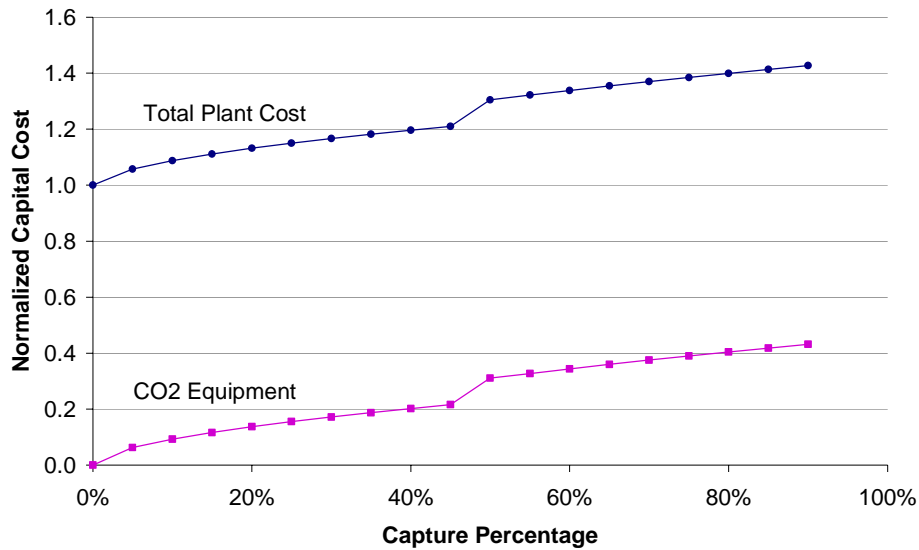
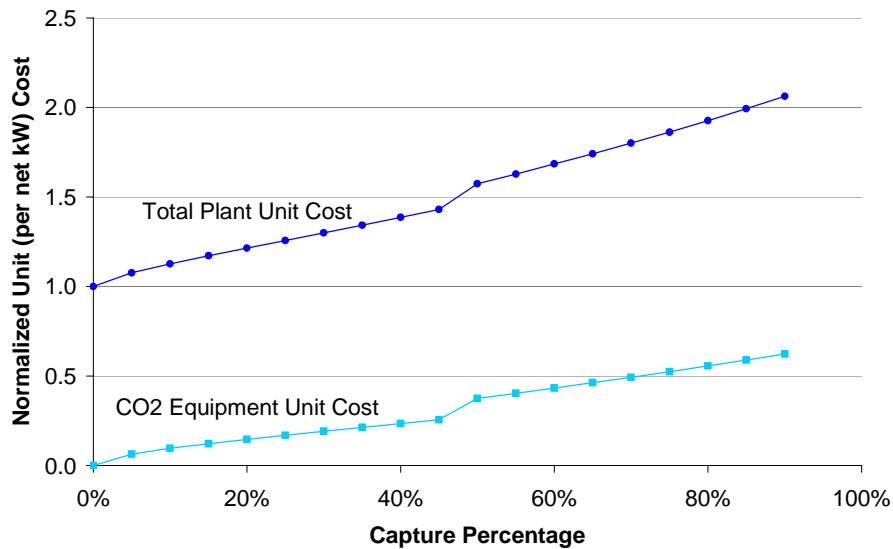

Figure 8-4 shows these capital costs on a per net kilowatt basis.

Figure 8-4. Unit Cost Dependency on Capture Percentage for SC PC Model



The figure above reflects the combined impact of increased capital costs and decreased plant efficiency with increasing capture percentage. This unit cost rises with a steeper slope than the total capital cost because of the reduced net power output. This results in the plant unit cost approximately doubling for full capture compared to no capture. These results also highlight that

considerable cost savings can be attained by reducing the capture percentage. At full capture, the plant unit cost is 2.06, compared to 1.57 at 50% capture, and 1.43 at 45% capture.

The cost of electricity (COE) in cents/kWh was computed and normalized to the COE at the non-capture condition. This is displayed as a function of capture percentage in Figure 8-5 as the separate contributions from operating and maintenance costs (O&M), fuel, and capital costs.

Figure 8-5. Cost of Electricity Dependency on Capture Percentage for SC PC Model

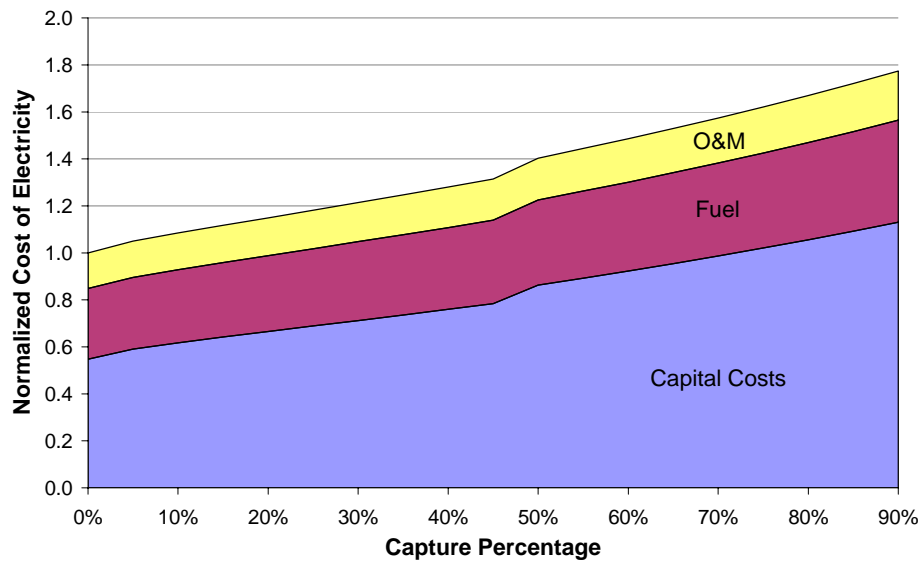

The figure above shows that the cost of electricity increases almost 80% in going from no capture to full capture. This figure also indicates that the majority of this increase is due to increased capital costs. The capital cost component of the normalized COE increases from 0.55 at no capture, to 0.86 at 50% capture, to 1.13 at full capture. The contribution from fuel increases as well due to the reduced efficiency of the power plant, and O&M costs increase due to additional consumables needed for capture. The jump in capital costs as a result of addition of the second train of CDR and compressor makes a noticeable difference in the normalized COE.

The cost of mitigation (cost of avoided emissions) is also important, as it represents the price of emissions that would be necessary to make capture economically equivalent to buying permits for emitting in the absence of subsidies or other government support. The costs of avoided and captured emissions are displayed in Figure 8-6 across capture percentages. These numbers do

not include the cost for transportation, storage, and monitoring, which can add \$5-\$15/ton. The reference plant with which these cost are computed is a non-capture supercritical PC plant.

Figure 8-6. Dependency of Avoided and Captured Emissions Cost on Capture Percentage for SC PC Model

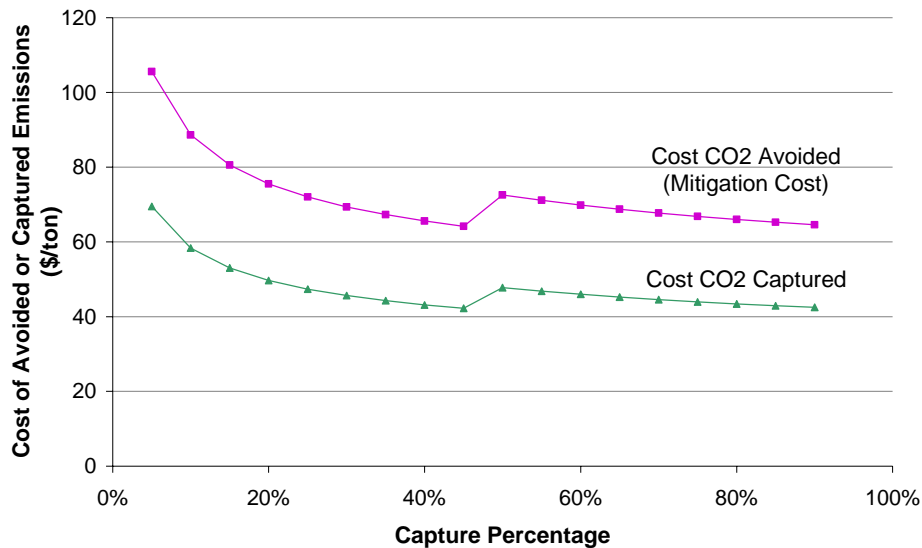

Figure 8-6 shows that the costs of avoided and captured emissions come down very quickly up to about 20% capture as the economies of scale pay off. They then level out some, experience the jump due to the technological breakpoint of the second train being added, and quickly level off again. Not shown on this graph is the fact that the costs would rise asymptotically as the capture percentage approaches 100% due to diminishing returns and the technological difficulty of reaching 100% capture. The captured cost is calculated using the *gross* captured emissions. The avoided cost is based on the *net* captured emissions, which is the *gross* captured emissions minus the emissions generated by the energy used in the capture process. Since the emissions are in the denominator of the cost calculations, avoided costs are greater than captured costs. It is the avoided emissions that are relevant to the economics of carbon dioxide mitigation, and the avoided cost is the number that should be compared to a carbon price generated by either a cap-and-trade system or a carbon tax.

The sensitivity of the economic results to the capture percentage at which the second trains of CDR and compressor must be added was also examined. Figure 8-7 shows the normalized unit cost across capture percentages with the maximum capture using a single-train CDR being 30% capture, 45% capture (the base case), 65% capture, and 90% capture. Beyond these capture

percentages, the second train must be added. The same cases were tested regarding the maximum capture for a single train of carbon dioxide compressors, but the difference in the results was negligible.

Figure 8-7. Sensitivity of Unit Cost to Maximum Capture of a Single CDR Train

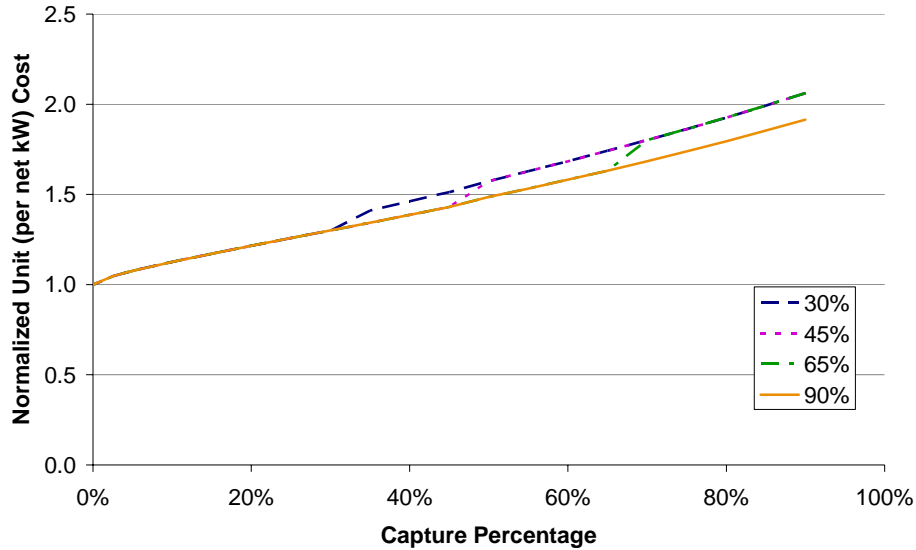
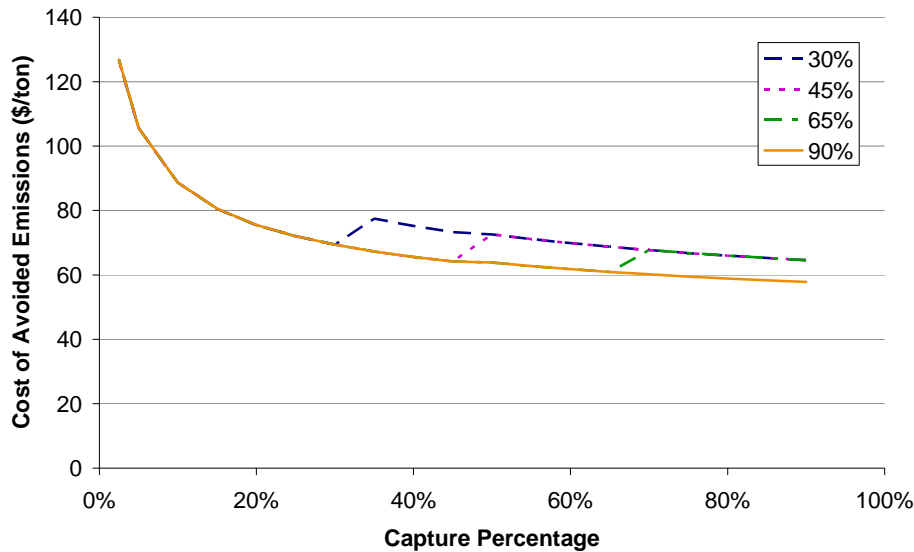

Figure 8-7 shows the difference the maximum capture achievable in a single train makes for the cost of electricity. The 30%, 45%, and 65% maximums all achieve the same normalized COE, 2.1, at the full-capture condition. However, if full capture can be achieved with a single train, the normalized unit cost is 1.9. This illustrates the cost savings that can result from economies of scale.

Figure 8-8 shows the cost of avoided emissions across capture percentages for the same cases.

Figure 8-8. Sensitivity of Mitigation Cost to Maximum Capture of a Single CDR Train



For the 30%, 45%, and 65% maximum capture with a single-train CDR, they all achieve the same cost of mitigation as the full-capture condition, and there is a local minimum just before adding the second train. If 90% capture can be achieved with a single train, the cost of full capture is the single lowest point on the curve as a result of economies of scale.

These sensitivities are important because they indicate possible cost-saving measures if partial capture is to be performed. While whether single or double trains are used for the compressors does not make a significant economic difference, the number of trains for the carbon dioxide removal unit has an impact on both normalized unit cost and cost of mitigation. The results indicate that for partial capture, if a single train is to be used, achieving the maximum capture possible with that train will result in the lowest mitigation cost due to economies of scale. However, unit cost will still increase with train capacity, and there can be reliability and flexibility advantages to having multiple trains. This implies that the choice of capture rate and number of trains will necessitate a trade-off among various economic and non-economic priorities.

The sensitivity to the prices of coal was also explored, as the cost of fuel will impact the overall project economics. Coal prices at 50%, 100%, 150%, and 200% of the base case price of coal (\$1.8049/MMBtu) were used. Figure 8-9 shows the sensitivity of the normalized COE to coal prices for these cases.

Figure 8-9. Sensitivity of Cost of Electricity to Coal Price for SC PC Model

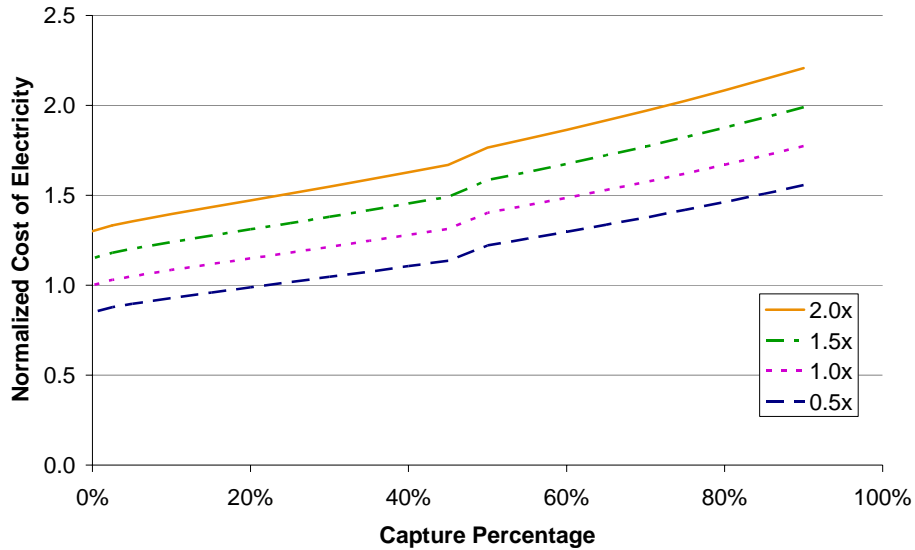

Figure 8-9 shows that as the coal price increases, the cost of electricity increases as well. The difference in COE between the highest and lowest coal prices is lower at the no-capture case and increases as capture is increased. This is due to decreased electrical productivity of the coal (plant efficiency) as capture is increased. Thus, increases in coal prices will have a greater impact on the COE of plants with higher capture rates.

These cases are also examined for the impact of coal price on the cost of avoided emissions, as shown in Figure 8-10.

Figure 8-10. Sensitivity of Cost of Mitigation to Coal Price for SC PC Model

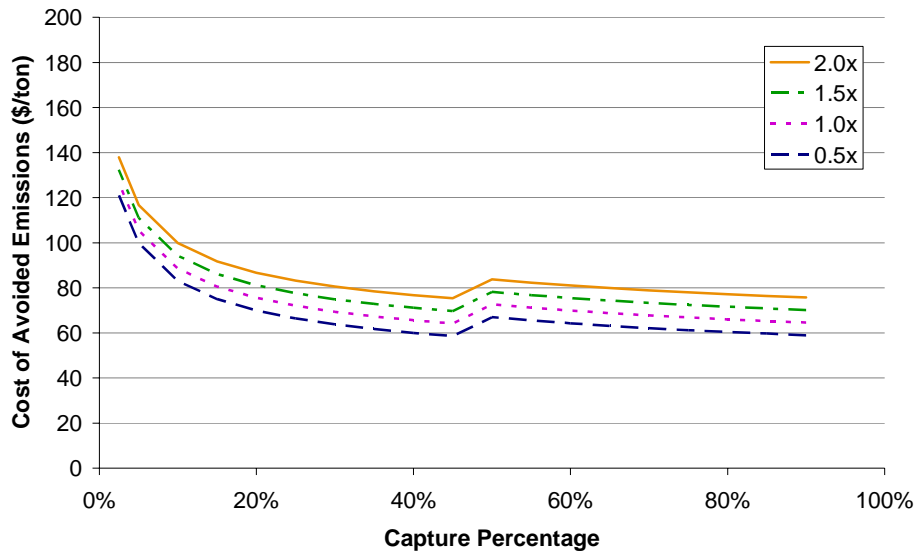
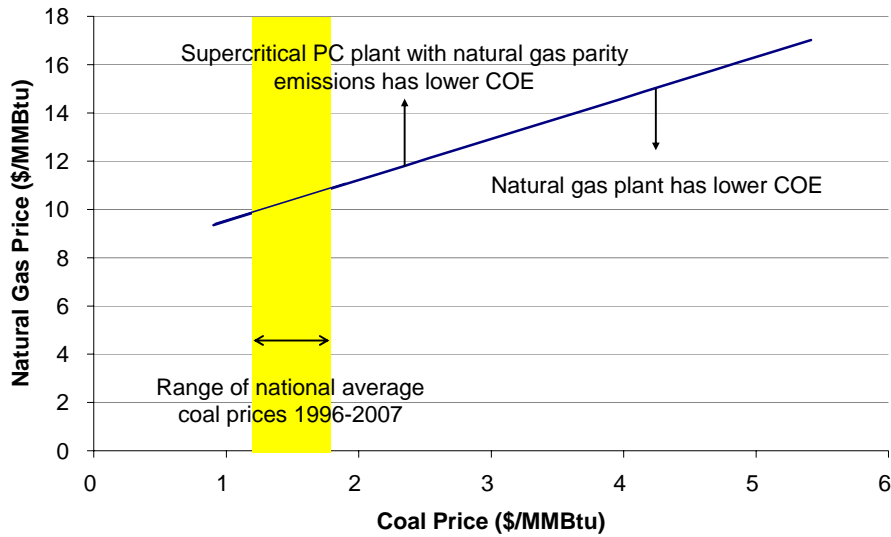

Figure 8-10 shows that the coal price also has an impact on the mitigation cost. However, the differential between the cost of emissions at the highest and lowest coal prices is constant, \$17/ton, across all capture percentages. This indicates that although the coal price affects the cost of mitigation, it only monotonically shifts the curves.

The level of capture that achieves emissions on par with natural gas emissions is of particular policy relevance. To reach the emissions level of the natural gas combined cycle plant used in the NETL study upon which these models are based, 797 lbs/MWh, the supercritical PC model requires 65% capture. If this level of emissions is to be achieved, the choice of building a natural gas plant or an SC PC plant with natural gas parity emissions will be partly dependent on the relative prices of the fuels. To investigate this comparison, the fuel prices at which the cost of electricity from both plants is equal was calculated. This analysis includes a charge of \$10 per ton of carbon dioxide for transportation and storage of the captured emissions, which adds \$0.40/kWh to the cost of electricity for the SC PC plant. These results are displayed in Figure 8-11.

Figure 8-11. COE Comparison of SC PC and NGCC Plants with Comparable Emissions



In Figure 8-11, the line represents the prices at which the cost of electricity from the natural gas plant and the 65% capture supercritical plant are equal. Above the line, the cost of electricity from the PC plant is lower, and below the line, the cost of electricity from the natural gas plant is lower. At a constant coal price, an increase in natural gas prices makes a PC plant more economic in terms of COE. At a constant natural gas price, an increase in coal price makes an NGCC plant more economic. The slope of the line indicates that this comparison is dependent on both fuel prices.

Because the prices to a power generator vary greatly from plant to plant, as discussed in Chapter 2, this indicates that some plants will fall above the line, while some will fall below. Thus, both types of plants would likely be built, dependent on the relative prices to the individual companies. Furthermore, it is possible that enactment of climate policies will raise natural gas prices and depress coal prices. This will make the coal plant with CCS more competitive based on cost of electricity. Power generators will have to make a decision based on current prices of the fuels as well as where they expect the prices to go during the lifetime of the plant.

9 IGCC PERFORMANCE AND ECONOMIC MODELING

9.1 EVALUATION METHODOLOGY

The main methodology for the IGCC evaluation is similar to the PC evaluation discussed in Chapter 8. Information from the National Energy Technology Laboratory's (NETL) "Cost and Performance Baseline for Fossil Energy Plants" was used because it contains the most complete set of the data necessary for this modeling. Concerns about uncertainty in *absolute* costs from the NETL report are ameliorated by focusing on *relative* costs. Relevant details of this model are presented in Appendix A.

To investigate partial capture for an IGCC plant, data from cases 1 and 2 from the NETL study were used. These cases use the General Electric Energy gasifier configuration. This gasifier was selected because it has the lowest cost in the full-capture case.²³² The partial capture model is based on the full-capture case 2, and capture is "reduced" from this case. The amount of capture achieved is theoretically determined by both the number of shift stages and the removal efficiency of the AGR. However, because other options have not yet been thoroughly evaluated for the purpose of carbon capture, as discussed in Chapter 7, a two-stage AGR with a removal efficiency of 95% is always used. With this AGR, which uses the common solvent Selexol, it was calculated that 28.7% capture can be achieved by "skimming," or without a shift reactor; this represents the minimum capture achievable. In this situation, the COS hydrolyzer is still used. With a single stage of shift, researchers have reported that the General Electric Energy configuration can achieve capture up to 78%.²³³ These options represent technological "breakpoints."

To achieve the desired rate of carbon capture, the amount of carbon monoxide that must be converted to carbon dioxide is computed. It is assumed that the ratio of 2 mols steam to one mol carbon monoxide is with reference to the amount of carbon monoxide desired to be converted, not all of the carbon monoxide in the stream. The necessary quantity of water gas shift catalyst

²³² Ibid.

²³³ Field, Randall (2009) "RE: Single shift conversion." Personal Communication. February 23, 2009.

is also assumed to be proportional to the desired carbon monoxide conversion. It is recognized that these assumptions will not necessarily hold true for practical implementation. However, further research into the relationship between steam ratio, catalyst use, and conversion is necessary to refine these assumptions and identify the best way to achieve partial conversion. An alternate assumption, that the 2:1 ratio is with respect to all of the carbon monoxide in the stream, was tested in the model. The difference in the economic results was found to be negligible: the cost of the shift reactor changed by approximately 11%, but the impact on all other economic outputs was no greater than 0.5%. This confirmed that the original assumption was acceptable for these purposes. As a result of this assumption and the copious amount of steam in the syngas exiting the gasifier due to it being slurry-fed, it is not necessary to add additional steam until beyond about 70% capture.

Flowrates and compositions are then tracked through the cooling, water knock-out, and AGR. The design of case 2 from the NETL study assumes that the carbon dioxide from the initial high-pressure flash is sufficiently pure for compression, transportation, and storage. As discussed in Chapter 7, this will not be true in reality; some volatile substances will also be present and must be separated. However, the lack of a clear resolution to this problem, plus the lack of data upon which to base such a cost estimate, led to the decision to maintain this assumption for this model.

Enthalpy values for the range of syngas compositions entering the combustion turbine were used to derive a relationship between carbon monoxide conversion and syngas enthalpy. This is used to compute the syngas enthalpy, and enough nitrogen is added to maintain a constant heat flow entering the combustion turbine regardless of capture rate, consistent with the NETL study. This holds constant the output of the gas turbine, but the power from the steam turbine decreases with capture. New auxiliary power demands are computed for the AGR auxiliaries and the compressor; changes in other auxiliary power are negligible. These values are used to calculate overall net output, heat rate, and efficiency.

New capacity and cost estimates are made for the shift reactors, AGR, compressors, and syngas expander. Because the equipment is integrated into the gas pathway, it is assumed that two equal-size trains are always used regardless of capture level. The relationship between

equipment capacity and cost, displayed as Equation 1 in Chapter 8, is again used. Due to data limitations, costs for these are computed using a standard capacity-cost exponent of 0.7, except for the syngas expander for which the exponent was calculated. These are used to compute total plant costs. O&M costs for consumables are computed with new quantity values for the COS catalyst and water gas shift catalyst. The cost of electricity is calculated in the same manner as for the PC cases. The costs of avoided and captured emissions are again calculated using the non-capture supercritical pulverized coal plant as the reference plant, as this provides a comparison of IGCC to the status-quo of PC technology.

There are a number of sensitivities to examine, as these parameters may vary by plant design and change as the technology develops. For the IGCC model, these include the capture percentage at which a second parallel compressor is needed. The impact of the AGR carbon dioxide removal efficiency on the maximum capture achievable by skimming is tested. The impact of the capture percentages at which it is necessary to add the second shift stage and second carbon dioxide compressor train are also explored. The choice between building a coal plant or natural gas plant will be influenced by the relative prices of these feedstocks, so sensitivity to the price of coal is examined.

Natural gas parity is of particular policy relevance. It is explored by achieving carbon dioxide emissions with the IGCC model comparable to the natural gas combined cycle plant in the NETL study, or 797 lbs/MWh. The data from this model run are then used to compare the cost of electricity from the IGCC and the NGCC. As this is influenced by the relative prices of these fuels, this analysis is performed as a sensitivity to these prices.

9.2 RESULTS

The General Electric Energy case for an IGCC plant was modeled as described above; the results are presented here. While the model cannot approximate capture below 28.7%, data from the non-capture case from the NETL study were used to plot corresponding 0% capture values. As for the PC results, cost numbers are normalized to the non-capture case due to uncertainty regarding capital costs, which is especially prevalent for IGCC plants.

The gross power and net power across the range of capture percentages is shown in Figure 9-1.

Figure 9-1. Plant Output Dependency on Capture Percentage for IGCC Model

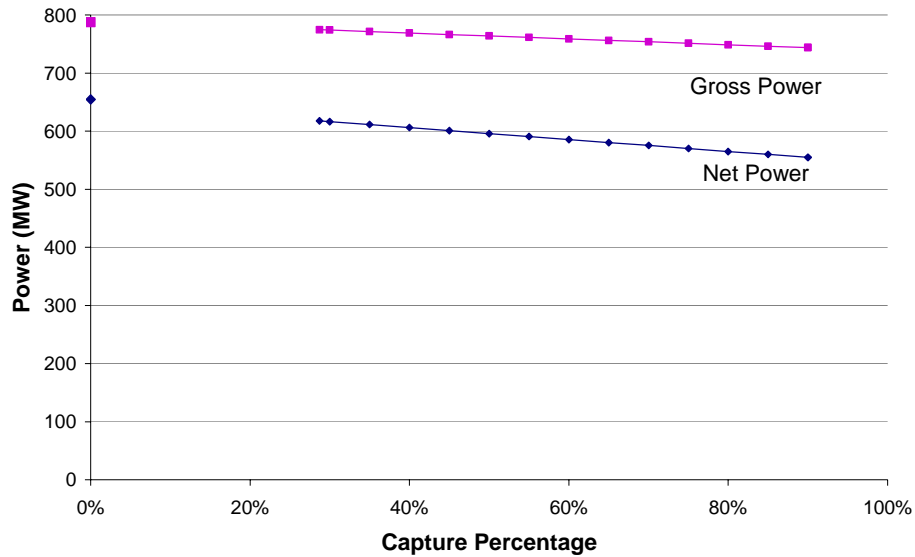

Figure 9-1 shows that both the gross and net power are roughly linear with respect to capture. While the gas turbine power is held constant due to the addition of nitrogen, the steam turbine and sweet gas expander exhibit reduced output as capture is increased. This results in decreasing gross power output, at 775 MW in the skimming case, to 744 MW at full capture; the non-capture case results in gross power of 787 MW. The difference between gross power and net power increases with capture percentage because of the additional auxiliary power demands that are necessary for the capture process, including the CO₂ compressors.

Figure 9-2 shows the power plant efficiency and heat rate as a function of capture percentage.

Figure 9-2. Plant Performance Dependency on Capture Percentage for IGCC Model

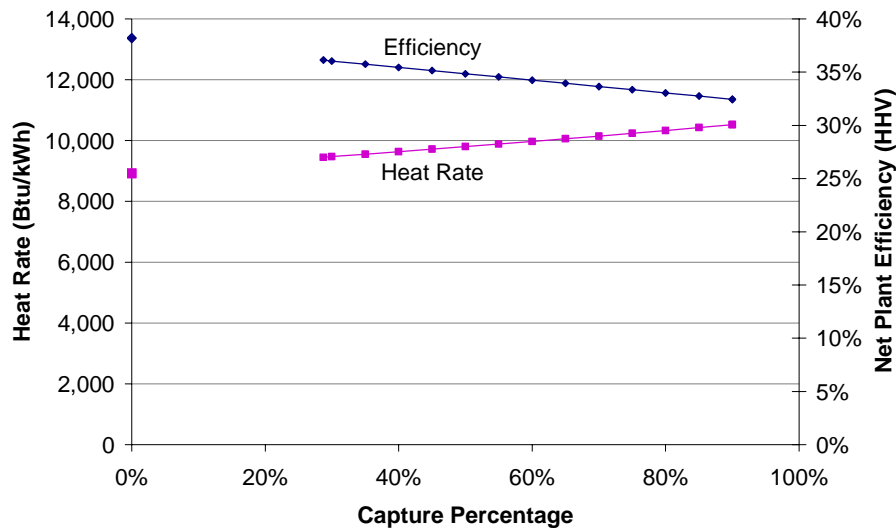
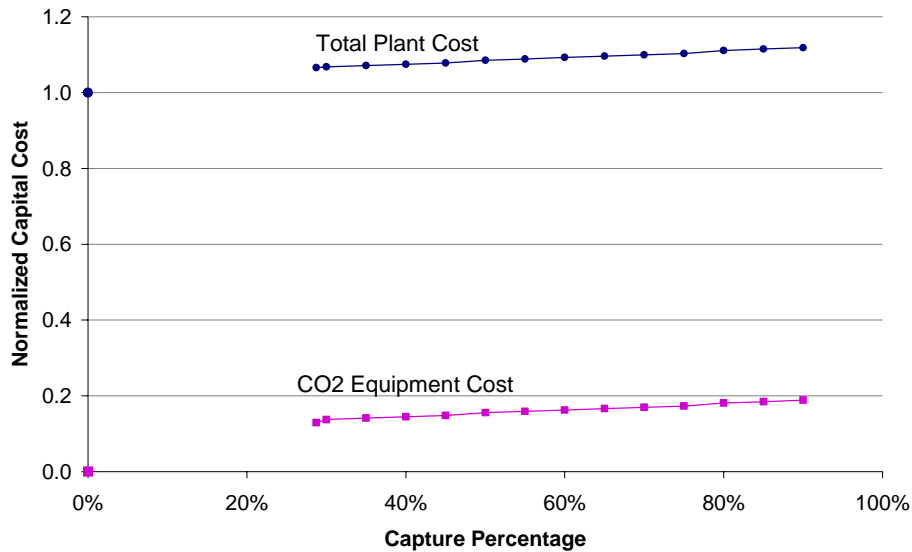

Figure 9-2 shows that the heat rate (on an HHV basis) and efficiency are also roughly linear with respect to capture rate. The heat rate increases from 8,922 Btu/kWh at no capture, to 9,450 Btu/kWh in the skimming case, then to 10,524 Btu/kWh at full capture, while the efficiency drops from 38%, to 36%, to 32%, respectively. The overall 6% efficiency penalty is half of the penalty for the PC model at full capture.

Figure 9-3 displays the total plant capital costs and the capital cost associated with the carbon dioxide capture equipment, normalized to the non-capture case, as a function of capture percentage. This group of carbon dioxide equipment includes the AGR, compressors, and their peripheral equipment like pumps and heat exchangers. This classification is not entirely accurate, as the first stage of the AGR is used for removal of hydrogen sulfide, but further resolution of the costs is not possible from the available data.

Figure 9-3. Capital Cost Dependency on Capture Percentage for IGCC Model



The figure above shows that the increase in capital costs is nearly linear with respect to capture level beyond the skimming case. Compared to no capture, the total plant cost is 7% higher at skimming and 12% higher at full capture. This indicates that some cost saving can be achieved by reducing the capture rate, but much less than for the PC case. A small jump can be seen in the carbon dioxide equipment cost from the skimming case, 28.7% capture, to the 30% capture case as a result of removal of the COS hydrolyzer and addition of a shift reactor. However, this and the addition of a shift reactor at 80% capture make negligible differences in total plant costs. This indicates that these technological breakpoints are not strongly economically significant. At the skimming case, the carbon dioxide equipment represents 12.6% of the total cost; at full capture, it represents 17%.

Figure 9-4 displays the corresponding unit costs on a per net kilowatt basis across capture percentages.

Figure 9-4. Unit Cost Dependency on Capture Percentage for IGCC Model

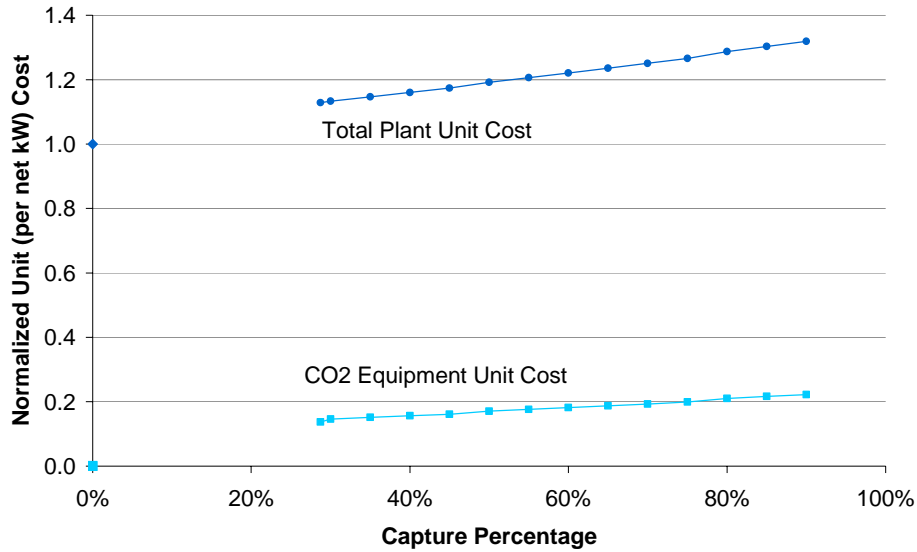

Figure 9-4 shows that the unit costs are also linear if capture is achieved. As in the supercritical PC model, the decreasing plant output with increased capture results in a steeper slope for the unit cost than for the capital cost. Compared to the PC case, the total plant unit cost savings for partial capture are small. For example, the normalized total plant unit cost at full capture is 1.32, compared to 1.17 at 45% capture, an 11% savings. However, a significant savings is possible in investment in the capture equipment. These relationships have these characteristics for IGCC because the capture equipment cost is small compared to the considerable expense of the base of the plant.

The cost of electricity was also computed and normalized. The contributions from capital costs, fuel, and O&M are presented in Figure 9-5 across capture percentages.

Figure 9-5. Cost of Electricity Dependency on Capture Percentage for IGCC Model

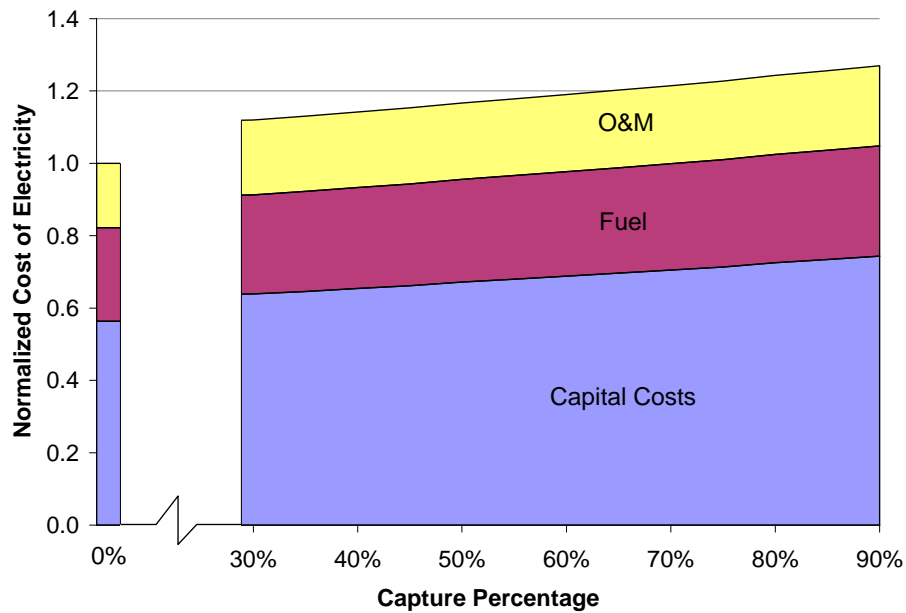

Figure 9-5 shows that the total cost of electricity and its components are also relatively linear with respect to capture level past the skimming condition. Compared to the non-capture case, the skimming condition's COE is 12% higher, and the full capture condition's COE is 27% higher. At increasing capture percentages, the increase in capital costs is greater than increases in fuel and O&M costs.

The cost of avoided emissions (mitigation cost) and cost of captured emissions across capture percentages are presented in Figure 9-6. These costs are again computed using a supercritical PC plant as the reference plant, as this presents a comparison of IGCC to the status-quo of pulverized coal technology in the United States.

Figure 9-6. Dependency of Avoided and Captured Emissions Cost on Capture Percentage for IGCC Model

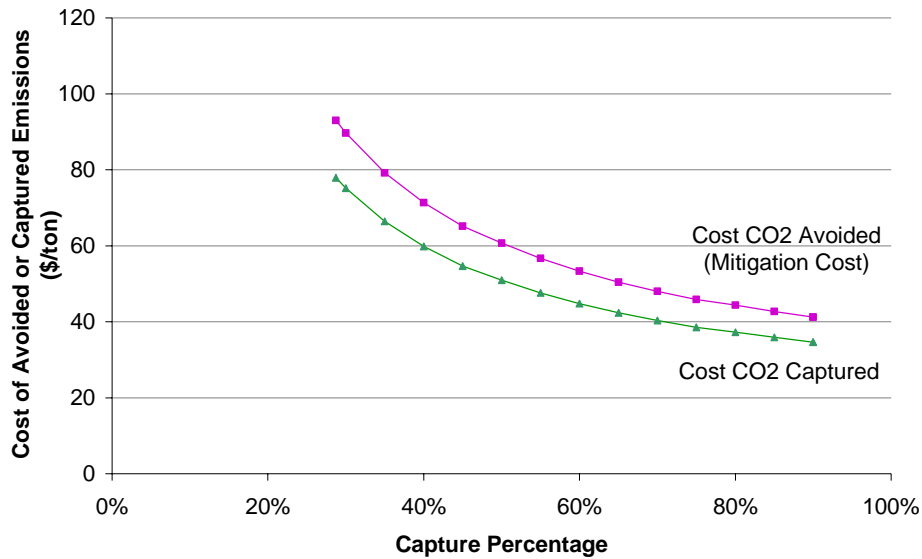
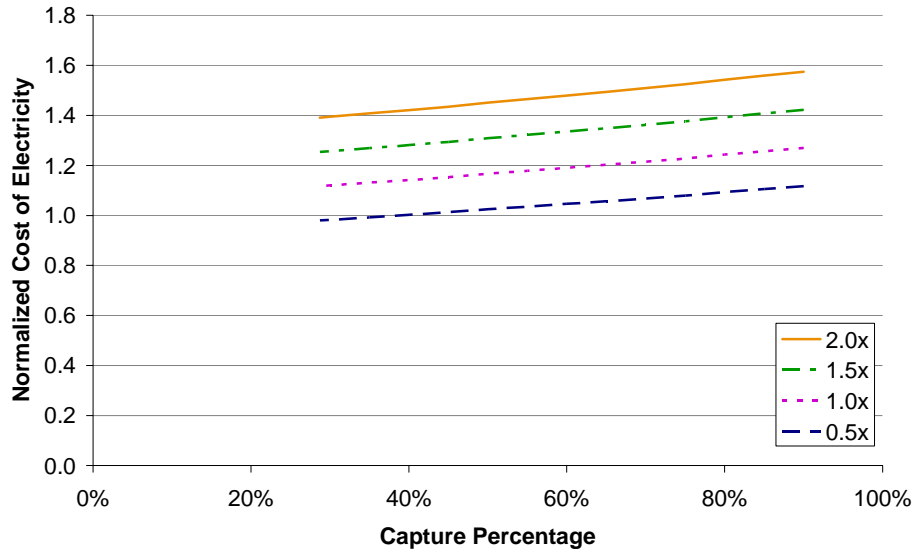

Figure 9-6 shows that there are substantial savings in captured and avoided cost by going to full capture for an IGCC. Anything less than full capture will result in higher costs, especially towards the skimming condition, which has the highest mitigation cost.

A number of sensitivities were tested for the IGCC model. The maximum capture achievable by a single stage shift and the maximum capture with a single compressor train were explored, but both variables made a negligible difference on plant economic measures, further confirming that the breakpoints are not strongly significant for economics. The carbon dioxide removal efficiency of the AGR was varied, as this determines, among other things, the maximum capture achievable in the skimming case. It was found that reducing the AGR efficiency to 85% reduces the skimming capture to 25.7%, and increasing it to 100% (such that all of the carbon dioxide exiting the gasifier is removed) results in skimming capture of 30.2%. This means that capture rates are not strongly dependent on the AGR efficiency within this range, although actual achievable numbers vary greatly by gasifier and operating conditions.

The sensitivity of the IGCC results to the price of coal was also tested. The same cases were used as for the PC model, namely, 50%, 100%, 150%, and 200% of the base coal price (\$1.8049/MMBtu). Figure 9-7 shows the COE for these cases as a function of capture percentage.

Figure 9-7. Sensitivity of Cost of Electricity to Coal Price for IGCC Model



As Figure 9-7 shows, the price of coal makes a clear difference in the normalized cost of electricity, although the differential between the COE for the highest price and lowest price is relatively constant across capture rates. Higher coal prices result in a shift of the entire curve.

The impact of these coal prices on the cost of mitigation is shown in Figure 9-8 across capture percentages. These are computed with the non-capture supercritical PC plant as the reference.

Figure 9-8. Sensitivity of Cost of Mitigation to Coal Price for IGCC Model

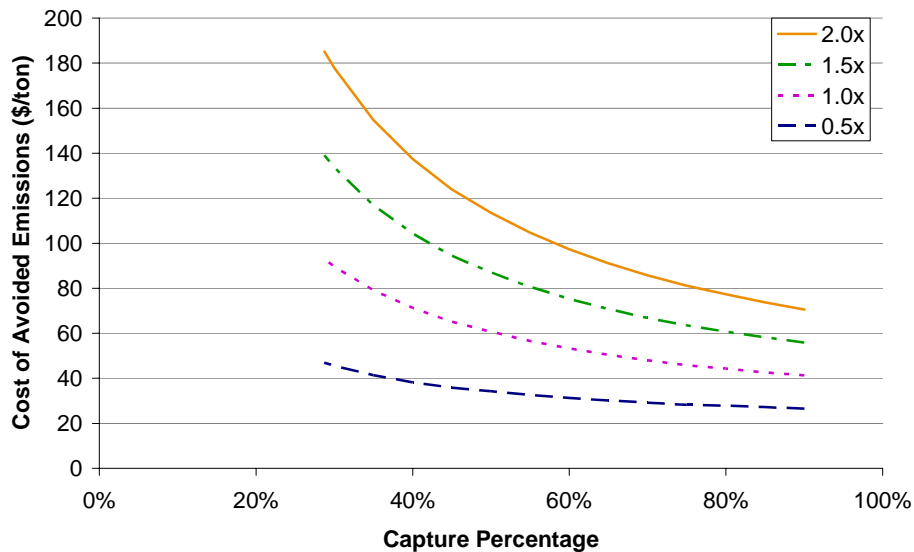
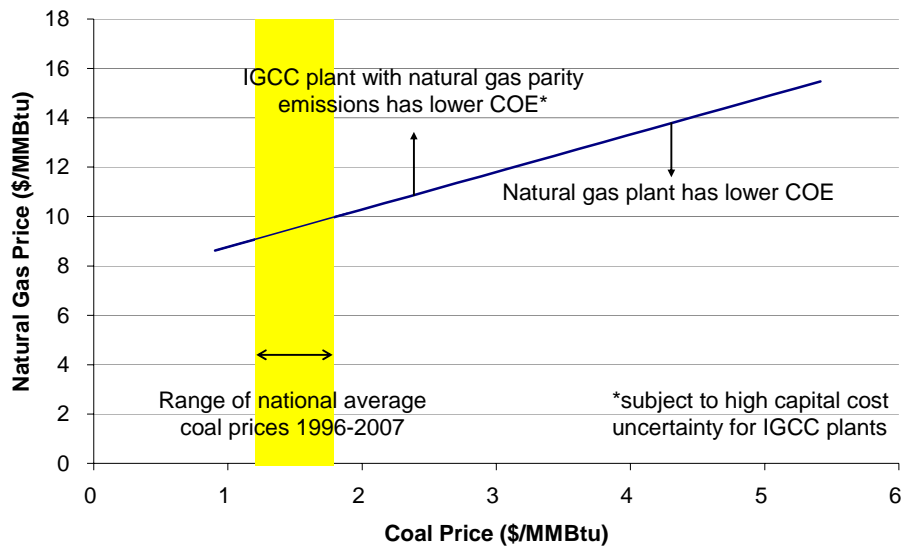

Figure 9-8 shows that the price of coal has an important impact on the cost of avoided emissions. As indicated by the difference in slopes, higher coal prices mean greater mitigation cost savings for going to full capture. The coal price makes the biggest impact at lower capture rates, where high prices amplify the mitigation cost penalty. At the skimming condition, the difference in mitigation cost between the highest and lowest cases is \$138, compared to a difference of \$44 at full capture. As the coal price is reduced, the mitigation cost becomes flatter.

As discussed in Chapter 4, the emissions rate of natural gas parity is of particular relevance. To achieve the level of emissions from the natural gas combined cycle plant used in the NETL study, 797 lbs/MWh, a capture rate of 59.3% was used for the IGCC model. The costs of electricity were compared, and a sensitivity was performed to examine the impact of the prices of fuel. These results are shown in Figure 9-9.

Figure 9-9. COE Comparison of IGCC and NGCC Plants with Comparable Emissions



These numbers account for a charge of \$10 per ton of carbon dioxide for transportation and storage. This adds \$0.40/kWh to the COE of the IGCC plant. It is also important to note that there is high uncertainty with this comparison due to the uncertainty regarding actual capital costs of IGCC plants.

The line in Figure 9-9 represents the prices at which the COEs from the plants are equal, with comparable emissions of carbon dioxide. As for the PC model results, this shows that the cost of

electricity comparison is dependent on both fuels. Lower coal prices and higher natural gas prices make the IGCC plant's cost of electricity lower, while higher coal prices and lower natural gas prices make the NGCC more economic. If natural gas prices rise relative to coal, as is a possible effect of climate policy, the IGCC plant becomes more economic. Which type of plant may be more economic will be partly dependent on the prices of coal and natural gas to a generator, which is highly dependent on location. Generators will also have to account for the prices they will expect to see over the plant's lifetime. As such, it is likely that under a policy of natural gas parity, both types of plants would be built.

10 DISCUSSION AND POLICY IMPLICATIONS

The objective of this work is to understand if partial capture represents a practical strategy for demonstrations and early deployment of carbon capture and storage. Such a strategy would be intended to:

- *Facilitate implementation of CCS technology.* The paradigm of full capture for CCS currently results in technological and economic challenges that deter implementation by first movers. Partial capture could reduce these challenges.
- *Accelerate the commercialization of CCS technology and abatement of carbon dioxide emissions.* By facilitating implementation, partial capture could get CCS technology into the marketplace more quickly, reducing emissions sooner, and expediting widespread deployment of full-capture systems.
- *Maintain a robust electrical sector.* The current “coal paralysis” could lead to artificial (not market-driven) overreliance on natural gas, which could be associated with increased imports, higher consumer electricity prices, and an increased risk of carbon lock-in. Partial capture could facilitate a portfolio of fuel and technology options, plus a reduced risk of carbon lock-in.

10.1 FACILITATED IMPLEMENTATION

For a PC plant, partial capture reduces technological challenges and provides significant cost savings. Lowering the capture rate reduces the severity of the technological “step-outs” associated with capture, particularly for steam extraction from the steam turbine and use of the carbon dioxide separation process. This will result in lower risk. By mitigating the efficiency penalty of capture, partial capture can help preserve ability to dispatch electricity to the grid, thereby reducing the risk of stranding the plant and helping to ensure that emissions reductions do occur. Reducing the capture rate produces a steep decrease in total plant cost, unit (per net kilowatt) cost, and cost of electricity, indicating substantial cost savings for partial capture. Beyond about 20% capture, the mitigation costs are roughly on par with the mitigation cost of full capture, so partial capture does not result in much of a mitigation cost penalty. As an example of cost savings, Table 10-1 below shows the differences in costs at 0% capture, 90% capture, and half way between, 45% capture.

Table 10-1. Comparison of Costs at 0%, 45%, and 90% Capture for an SC PC Plant

<i>Percent Capture</i>	<i>Normalized Unit (per net kW) Cost</i>	<i>Mitigation Cost (\$/ton)</i>
0%	1	-
45%	1.43	64
90%	2.06	64

Comparison of 45% Capture to 90% Capture

Capture Process Unit Cost	59% savings
Total Plant Unit Cost	31% savings
Mitigation Cost	Same

The table above shows that the cost savings as a result of reducing the capture percentage can be significant while maintaining a mitigation cost comparable to full capture.

For an IGCC plant, partial capture reduces technological challenges, but cost savings are relatively small. The technological step-outs are not as extensive for partial capture as for full capture for IGCC. In particular, the use of water gas shift reactors can be reduced, and a hydrogen turbine can be avoided or derating of the syngas turbine can be reduced. Because partial capture can improve efficiency compared to full capture, the ability to dispatch electricity to the grid can be preserved. This can help reduce the risk of stranding the plant, and ensured operations means that emissions will be abated. However, IGCC plants are significantly more capital-intensive than PC plants, and the capture equipment represents a small fraction of the total investment. As a result, the savings achieved by partial capture are small compared to the substantial cost of the base plant and compared to the savings for PC plants. Furthermore, the mitigation cost decreases steadily as capture is increased. Thus, there is a loss of economies of scale (i.e., a mitigation cost penalty) associated with partial capture. An example of the cost differences between three different capture percentages for an IGCC is presented in Table 10-2. In this table, the unit cost is normalized to the cost of a non-capture supercritical plant, highlighting the difference in costs between IGCC plants and PC plants.

Table 10-2. Comparison of Costs at 0%, 45%, and 90% Capture for an IGCC Plant

<i>Percent Capture</i>	<i>Normalized Unit (per net kW) Cost</i>	<i>Mitigation Cost (\$/ton)</i>
0%	1.15	-
45%	1.35	65
90%	1.52	41

Comparison of 45% Capture to 90% Capture

Capture Process Unit Cost	46% savings
Total Plant Unit Cost	11% savings
Mitigation Cost	59% increase

Table 10-2 shows that the unit cost of a base IGCC plant is 15% greater than that for a PC. The unit cost savings afforded by partial capture are significant for the capture process, but the total plant savings are small, especially when compared to those for a PC plant (displayed in Table 10-1). It also emphasizes a notable mitigation cost penalty associated with reduced capture percentages. Therefore, it is less economically efficient to pursue partial capture for an IGCC, although the mitigation of technological challenges and preservation of dispatch ability could also be valuable to a project developer.

The benefits of partial capture for both PC and IGCC are summarized in Table 10-3.

Table 10-3. Summarized Benefits of Partial Capture for PC and IGCC Plants

Benefit	PC	IGCC
Mitigation of Technological "Step-outs"	Yes	Yes
Improved Ability to Dispatch	Yes	Yes
Savings for Incremental Capture Cost	Significant	Significant
Savings for Total Plant Unit Cost	Significant	Small
Comparable Mitigation Cost	Yes	No

Table 10-3 shows that the technological and financial challenges associated with full capture are strongly reduced for partial capture for a PC. This indicates that partial post-combustion capture for PC can be more easily implemented. For an IGCC, dispatch and technological issues benefit from partial capture, but the economic implications are varied. Benefits from partial capture may be marginal compared to the considerable cost of the base plant. This indicates that the decision between full capture and partial capture for IGCC will be motivated by a trade-off of individual economic and technological priorities.

10.2 ACCELERATED COMMERCIALIZATION AND EMISSIONS ABATEMENT

The above analysis indicates that a partial capture strategy could provide significant benefits when applied to PC plants, but the implications for IGCC plants are mixed. For PC plants, a strategy of partial capture will reduce technological and economic challenges, resulting in implementation that is more rapid and in more contexts. In addition to sooner abatement of emissions, this will generate important technical and operational learning and cost reductions. Such implementation will also provide the reassurances necessary for the technological and financial communities. These benefits will facilitate phasing-in of technological step-outs and the transition to full capture systems. Thus, partial capture can actually expedite widespread deployment of full capture post-combustion capture systems. This will accelerate decoupling of energy use and carbon dioxide emissions.

Partial capture can be especially valuable for government-funded demonstration projects for post-combustion capture. Under a limited budget, more partial capture projects can be funded, and these can be spread out over more contexts. These projects can provide sources of carbon dioxide for important storage tests as well. This will result in faster accumulation of the knowledge necessary for further development and deployment of CCS. Under a budget constraint, more can likely be gained from supporting partial-capture demonstrations than full-capture demonstrations. Thus, partial post-combustion capture is a sensible strategy for government-funded demonstration projects.

Due to the number of existing PC plants in the world, post-combustion capture is especially valuable. PC plants are particularly amenable to retrofitting for CCS. The sooner post-combustion capture is commercialized, the sooner it can be retrofitted to existing PC plants. The strategy of partial capture will accelerate this process, helping to reduce emissions from the existing electricity infrastructure sooner. Partial capture may also be the most feasible strategy for these retrofits, as retrofitting existing PC plants for full capture could be prohibitive due to space constraints, and the typical lower efficiency of existing plants means that they are at a heightened risk of stranding. Thus, partial capture may offer a feasible retrofit where full capture may not. Additionally, more rapid commercialization of full capture CCS will also mean that plants originally built for partial capture can be upgraded to full capture sooner, further reducing

emissions. Thus, the partial capture strategy affords options to maximize the emissions reduction potential of post-combustion capture.

Compared to full capture, partial capture for IGCC may be more implementable for some individual developers because technological challenges are reduced, ability to dispatch electricity to the grid can be preserved, and some cost can be saved. However, IGCC base plant technology itself is very expensive and relatively new, and therefore it represents a greater hurdle for implementation than the capture portion. Compared to the expense and challenge of implementing base IGCC technology, the marginal benefits afforded by partial capture may not be significant. Although partial capture provides some benefits compared to full capture, a strategy of partial capture is unlikely to facilitate implementation of IGCC technology, which is the necessary platform for coal-fired pre-combustion capture. For example, if partial capture was to be implemented for the FutureGen project, the savings would not significantly reduce the overall project costs, which is currently the biggest barrier to its implementation. Therefore, without established commercialization of IGCC technology, the prospects for partial capture accelerating the commercialization of pre-combustion capture are slim.

10.3 ROBUST ELECTRICAL SECTOR MAINTAINED

A healthy electricity sector should include a diversity of options for fuel and technology. It is generally accepted that portfolios of options are beneficial, even vital, to a healthy market-based economy. This can be especially important for the electrical sector because diversity can provide a cushion against changes like varying fuel and commodity prices.

Partial capture preserves multiple technology options. This work shows that there is no capture percentage that is clearly optimal across all issues. Power generators will have to trade off values such as total cost, cost of electricity, and mitigation cost against technological challenges and risks of stranding, even if there is a price on carbon emissions. Each individual can ensure that their own priorities are met by selecting an appropriate technology and capture rate. This will likely result in beneficial diversity of selections.

Renewables are not yet suitable for baseload electricity because of intermittency, transmission, and infrastructure issues, and social and economic concerns make the future of nuclear power uncertain. This leaves coal and natural gas as the remaining fuel options for expanding the United States' baseload electricity in the near term. Because of carbon dioxide emissions, some have proposed a moratorium against new coal-fired power plants. However, even the Secretary of Energy acknowledged in his Senate confirmation hearing that this would be impractical during the transition to a low-carbon energy system.²³⁴ Yet, the current “coal paralysis” has led to practically a de-facto moratorium against coal. This could lead to overreliance on natural gas, which can be associated with high and volatile prices. Under a cap-and-trade scenario, without the availability of CCS for coal, these prices may be pushed even higher.²³⁵

Partial capture provides a portfolio of fuel options and a means to ease the coal paralysis. This work shows that the choice between coal and natural gas, with comparable levels of emissions, is partly dependent on the prices of the fuels. It is thus likely that both fuels will be utilized, dependent on prices which vary greatly by location. This will help avoid overreliance on natural gas and provide an important hedge against the possibility of natural gas prices rising significantly in the future. There are also distinct advantages from using coal due to its domestic abundance and lower prices. Thus, a clear near-term policy of partial capture would facilitate obtaining the advantages of coal again and ensure that a full portfolio of fuel options is available.

There is momentum for a policy of natural gas parity, which would require emissions from coal plants to be comparable to emissions from natural gas plants. This would require 40-65% capture, depending on the types of plants being compared. In addition to all of the benefits of partial capture stated above, a policy of natural gas parity is particularly appropriate because it would put these fuels on a level regulatory playing field.

Given the likelihood of a price on carbon from a cap-and-trade system or carbon tax, it would also be beneficial to have a minimized risk of carbon lock-in. Carbon lock-in refers to emissions

²³⁴ LoBianco

²³⁵ Hoppock, Bean, et al.

from a plant that cannot be economically reduced or captured. Reducing this risk means ensuring that plants can be economically retrofitted to reduce their emissions.

The prospect of carbon lock-in is a concern for both coal and natural gas. CCS technology can be more economically applied to coal plants than natural gas plants due to the higher partial pressure of carbon dioxide from burning coal. This leads to a greater ability to retrofit and a lower risk of carbon lock-in for coal plants than natural gas plants. If a coal plant is built with partial capture, retrofitting for full capture could be facilitated as well. For natural gas, it is likely that in the near term it will be prohibitively expensive to retrofit for capture. Therefore, even under a policy that requires the same emissions rates, coal plants with CCS provide a lower risk of lock-in than natural gas plants, and therefore a more robust electricity sector.

11 CONCLUSIONS AND FUTURE WORK

11.1 CONCLUSIONS

Partial capture (capture of less than nominally 90% of emissions) is of interest as a potential strategy to:

Facilitate implementation of CCS technology. CCS is ready to be demonstrated, but technological and economic hurdles and risks have discouraged implementation by first movers. For both pulverized coal (PC) and integrated gasification combined cycle (IGCC) plants, full capture (capture of nominally 90% of emissions) requires technological “step-outs” with which industry is not sufficiently familiar. A substantial capital investment is also needed for full capture. The efficiency penalty associated with full capture may result in the plant being stranded, and the intended emissions reductions would not take place.

Accelerate the commercialization of CCS technology and abatement of carbon dioxide emissions. If CCS technology can be introduced into the marketplace sooner, development and deployment can take place more rapidly, thereby reducing emissions and accelerating decarbonization of the electricity sector.

Maintain a robust electricity sector. If the current “coal paralysis” continues, fuel-switching can create an artificial (not market-driven) overreliance on natural gas for electricity production. This could be associated with increased imports and exacerbation of already high and volatile prices, including higher electricity prices for consumers, and an increased risk of carbon lock-in. Partial capture can provide a viable option to maintain diversity in the electricity sector.

For pulverized coal plants, partial capture is more implementable than full capture for first movers because:

Partial capture is technologically easier to achieve than full capture. The technology necessary to implement partial capture represents less extensive step-outs for both equipment and processes. This reduces the risk associated with implementation.

Partial capture mitigates the impact on plant output and efficiency, preserving dispatch ability. The net output, gross output, efficiency, and heat rate are generally linear with respect to capture percentage. Partial capture affords lower risk of stranding and improved overall profitability by improving ability to dispatch electricity to the grid.

Partial capture results in significant cost savings compared to full capture for PC plants. Capital costs are lower because smaller or fewer pieces of equipment are necessary. This also results in lower unit (per net kilowatt) costs and lower costs of electricity. Due to the high cost of the capture equipment relative to the base plant, economies of scale and technological “breakpoints,” where discrete changes in equipment are necessary, have noticeable impacts on cost metrics. Cost savings as a result of partial capture are significant for PC plants for all cost metrics.

Partial capture can be achieved while maintaining a reasonable cost of mitigation (\$/ton of avoided emissions) for PC plants. Beyond about 20% capture, the mitigation cost is comparable to the cost at full capture.

For IGCC plants, partial capture may be more implementable than full capture for some first movers, but the overall implications are mixed, because:

Partial capture is technologically easier to achieve than full capture. As for PC plants, partial capture reduces the severity of technological step-outs, and thus reduces risk.

Partial capture mitigates the impact on plant output and efficiency, preserving dispatch ability. For IGCC plants, the net output, gross output, efficiency, and heat rate are generally linear with respect to capture percentage, as for PC plants. This can afford

improved ability to dispatch electricity to the grid and therefore lower risk of stranding and improved profitability.

The cost savings associated with partial capture for IGCC may not be significant. Capital cost, unit (per net kilowatt) cost, and cost of electricity are lower because smaller or fewer pieces of equipment are necessary for partial capture. For IGCC plants, if any capture is to be achieved, the cost metrics are generally linear with respect to capture percentage. Although there are cost savings for the capture process itself, the savings from partial capture are small with respect to the greater cost of the base IGCC plant. They are also small compared to the savings for a PC plant.

Partial capture results in a penalty in mitigation cost (\$/ton of avoided emissions) for IGCC plants. The mitigation cost for IGCC decreases as capture percentage is increased, indicating economies of scale, and resulting in a mitigation cost penalty for capture rates below full capture.

Partial capture is overall more implementable than full capture for PC plants. For IGCC plants, partial capture may be more implementable than full capture, subject to a trade-off of technological and economic priorities. All economic and technological challenges for PC are mitigated by partial capture. The economic argument for partial capture is weaker for IGCC, but improved dispatch ability and technological step-outs are valuable benefits of partial capture that must be weighed.

A strategy of partial capture for PC plants will accelerate commercialization of post-combustion CCS and abatement of carbon dioxide emissions because:

It will result in sooner and more rapid deployment of post-combustion CCS systems. This is crucial for generating vital technical and operating knowledge, obtaining possible cost reductions, and making the technological and financial communities comfortable with CCS.

It will expedite the long-term goal of widespread use of full-capture CCS systems and maximization of the emissions abatement potential of post-combustion CCS. As the post-combustion CCS industry grows and matures as a result of sooner implementation, technological step-outs can be phased in, and deployment of full-capture systems can be expedited. The implementation of CCS for retrofitting will be accelerated as well, allowing CCS to make a more significant contribution to emissions reductions.

A strategy of partial capture for IGCC will not likely accelerate commercialization of pre-combustion CCS and abatement of carbon dioxide emissions because:

Compared to the cost and challenge of implementing the base IGCC plant technology, the benefits of partial capture are small. It is currently difficult to build even a non-capture IGCC plant, so this represents a greater hurdle than implementation of capture. Without commercial establishment of IGCC technology, the marginal benefits of partial capture are unlikely to facilitate commercialization of pre-combustion capture.

A strategy of partial capture will help maintain a robust electricity sector because:

Partial capture creates a portfolio of technology options. There is no single optimal choice of PC or IGCC technology and capture percentage. Multiple reasonable options will allow individual power generators to trade off various metrics subject to their own priorities and constraints.

Partial capture preserves a diverse fuel portfolio and protects consumers. Even under a policy of natural gas parity, which would require 40-65% capture from coal plants, it is likely that both fuels would be utilized, subject to local fuel prices for a generator. This can help avoid overreliance on natural gas and provide a hedge against high consumer prices that may result from this overreliance.

Natural gas parity is a practical and appropriate near-term policy. This policy, for which there is momentum, would put coal and natural gas on a level regulatory playing

field. These fuels can compete on a cost of electricity basis under such a policy. In addition to the benefits of partial capture discussed above, this would ensure that the same emissions reductions occur as in the alternative situation of fuel-switching from coal to gas.

Partial capture for coal will result in lower risk of carbon-lock in compared to natural gas. It is more expensive to achieve carbon capture at natural gas plants than at coal plants. Coal plants can more easily and more economically be retrofitted for full-capture CCS, especially if originally built with partial capture.

11.2 FUTURE WORK

While this study represents an important first step toward understanding the full range of options for implementation of carbon capture, there remains beneficial work to be done. The models developed for this study utilize assumptions that may not be realistic for actual implementation. Some of these issues are not well understood and are still being actively researched, such as the relationship between shift steam and carbon monoxide conversion, and how to deal with impurities from the initial high-pressure flash solvent regeneration for an IGCC. As such, these models can be refined to incorporate new research, new economic data, and new technology options. Further sensitivities can be explored, including for parameters at which research is aimed, such as the regeneration energy of chemical solvents. Models for new plant configurations can be developed, including, for example, different gasifier technologies or implementation of partial capture at natural gas plants. One of the greatest risks with partial capture is the possibility of carbon lock-in. This should be explored by examining the impact of retrofitting plants originally designed for partial capture, as well as how partial capture could be designed to facilitate later retrofitting for full capture.

REFERENCES

- "2006 IPCC Guidelines for National Greenhouse Gas Inventories." (2006) Intergovernmental Panel on Climate Change, IPCC National Greenhouse Gas Inventories Programme.
- An Act to Minimize Carbon Dioxide Emissions from New Coal-powered Industrial and Electrical Generating Facilities in the State. (2008) LD 2126, State of Maine Legislature. Version April 2, 2008.
- Adam, David (2008) "Coal power policy under attack from top scientists." The Guardian. April 3, 2008.
- "Advanced Coal Power Systems with CO₂ Capture: EPRI's *CoalFleet for Tomorrow* Vision." (2008) Electric Power Research Institute. Interim Report, September 2008.
- "AECI suspends plans to build Norborne power plant." (2008) Associated Electric Cooperative Inc. March 3, 2008.
- American Clean Energy and Security Act. (2009) Version March 31, 2009.
- "Annual Energy Review." (2008) Energy Information Administration. June 23, 2008.
- "Annual United States Natural Gas Industrial Price." (2008) U.S. Energy Information Administration. Retrieved August 26, 2008, from <http://tonto.eia.doe.gov/dnav/ng/hist/n3035us3A.htm>.
- "Articles on Coal." (2008) SourceWatch, CoalSwarm. Retrieved August 26, 2008, from http://www.sourcewatch.org/index.php?title=Articles_on_coal.
- "Assumptions to the Annual Energy Outlook 2008." (2008) Energy Information Administration. June 2008.
- "Average Cost of Coal Delivered for Electricity Generation by State, Electric Power Monthly with data for December 2008." (2009) Energy Information Administration. Retrieved April 1, 2009, from http://www.eia.doe.gov/cneaf/electricity/epm/table4_10_a.html.
- "Average Cost of Natural Gas Delivered for Electricity Generation by State, Electric Power Monthly with data for December 2008." (2009) Energy Information Administration. Retrieved April 1, 2009, from http://www.eia.doe.gov/cneaf/electricity/epm/table4_13_a.html.
- "Avista Issues Electric Resource Plan." (2007) Avista Corporation. September 4, 2007.
- Ball, Jeffrey (2008) "Wall Street Shows Skepticism Over Coal." The Wall Street Journal. February 4, 2008.
- Bauer, Scott (2008) "Wis. governor says no to coal for power plants." Chicago Tribune. August 1, 2008.
- "Bill Signing Finalizes Year-Long Push for Clean Coal Portfolio Standard in Illinois." (2009) PR Newswire. January 12, 2009.
- "A Blueprint for Legislative Action." (2009) United States Climate Action Partnership. January 2009.
- Bohm, Mark (2006) Capture-Ready Power Plants - Options, Technologies and Economics. Engineering Systems Division, Massachusetts Institute of Technology. Cambridge, MA. June 2006.
- "Bowie Power Station Announces Plan to Run Solely on Clean Natural Gas." (2007) Energy-Arizona. August 31, 2007.

Bradner, Tim (2008) "Agrium blames construction costs, financing environment for cancellation of coal gasification project for Kenai fertilizer plant." Alaska Journal of Commerce. March 14, 2008.

Brown, Matthew (2007) "Idaho Power gives up on coal-fired plant." Idaho Statesman. November 7, 2007.

"California Public Utilities Sets Greenhouse Gas Emissions Performance Standard." (2007) California Public Utilities Commission. January 25, 2007.

"Carbon Capture and Sequestration: Framing the Issues for Regulation." (2008) The CCSReg Project. December 2008.

Carbon Capture and Storage Early Deployment Act. (2008) H.R. 6258, United States House of Representatives. Version June 12, 2008.

Carbon Dioxide Capture from Existing Coal-Fired Power Plants. (2006) National Energy Technology Laboratory, U.S. Department of Energy.

"Carbon Dioxide Emissions from the Generation of Electric Power in the United States." (2000)

Carpenter, Tim (2007) "Holcomb plant at center of emissions conflict." The Capital-Journal. September 23, 2007.

Chester, Steven E. (2007) "Decision of the MDEQ Regarding IGCC in BACT Analysis." Personal Communication. December 20, 2007.

Chupka, Marc W. and Gregory Basheda (2007) "Rising Utility Construction Costs: Sources and Impacts." The Brattle Group, prepared for the Edison Foundation. September 2007.

"Citing GHG emissions, EPA board remands Mich. permits." (2009) Environment & Energy Daily. February 20, 2009.

"Climate Change Law Alert: Washington State Adopts GHG Emissions Reduction Legislation." (2008) Stoel Rives Energy Group. May 4, 2007.

Climate Security Act of 2007. (2007) S. 2191, United States Senate. Version October 18, 2007.

"CO2 Capture Ready Plants." (2007) IEA Greenhouse Gas R&D Programme. May 2007.

"Coal plants cancelled in 2007." (2008) SourceWatch, CoalSwarm. Retrieved August 26, 2008, from http://www.sourcewatch.org/index.php?title=Coal_plants_cancelled_in_2007.

"Coal plants cancelled in 2008." (2008) SourceWatch, CoalSwarm. Retrieved January 19, 2009, from http://www.sourcewatch.org/index.php?title=Coal_plants_cancelled_in_2008.

"Coal power goes on trial across U.S." (2008) MSNBC. January 14, 2008.

"Cost and Performance Baseline for Fossil Energy Plants." (2007) National Energy Technology Laboratory. August 1, 2007.

Davidson, Paul (2008) "Coal king Peabody cleans up." USA Today. August 8, 2008.

"DOE Announces Restructured FutureGen Approach to Demonstrate Carbon Capture and Storage Technology at Multiple Clean Coal Plants." (2008) U.S. Department of Energy, Office of Fossil Energy. January 30, 2008.

Ecke, Richard (2008) "Plant needs to meet new standards to sell power to Washington." Great Falls Tribune. June 29, 2008.

Efstathiou, Jim (2008) "Climate Laws 'Pointless' Without Coal Plant Ban, Scientist Says." Bloomberg. April 23, 2008.

EIA-767 Data Files: Annual Steam-Electric Plant Operation and Design Data. (2005) Energy Information Administration. August 10, 2007.

"Electric Power Annual with data for 2007." (2009) Energy Information Administration. January 21, 2009.

Energy Independence and Security Act of 2007. (2007) H.R. 6, United States House of Representatives. Version December 19, 2007.

"Engineering Feasibility and Economics of CO2 Capture on an Existing Coal-Fired Power Plant: Final Report." (2001) Alstom Power Inc., ABB Lummus Global Inc., Alstom Power Environmental Systems, American Electric Power.

"EPA Finds Greenhouse Gases Pose Threat to Public Health, Welfare / Proposed Finding Comes in Response to 2007 Supreme Court Ruling." (2009) U.S. Department of Energy, U.S. Environmental Protection Agency. April 17, 2009.

Executive Order Number 07-127: Establishing Immediate Actions to Reduce Greenhouse Gas Emissions within Florida. (2007) Office of the Governor, State of Florida. July 13, 2007.

"Fact Sheet: American Recovery and Reinvestment Act (Economic Stimulus Package)." (2009) American Public Power Association. February 2009.

"Fact Sheet: Energy Independence and Security Act of 2007." (2007) The White House, Office of the Press Secretary. December 19, 2007.

"Fact Sheet: Environmental Permitting of Coal-Fired Power Plants in Michigan." (2007) Michigan Department of Environmental Quality. June 29, 2007.

Fanelli, Patrick (2008) "NYPA Withdraws Support For North Tonawanda Clean Coal Project." Post-Journal. July 17, 2008.

Field, Randall (2009) "RE: Single shift conversion." Personal Communication. February 23, 2009.

"Final Workshop Report: Interim Emissions Performance Standard Program Framework, R.06-04-009, June 21-23, 2006." (2006) California Public Utilities Commission, Division of Strategic Planning. October 2, 2006.

"Florida Public Service Commission Denies Determination of Need for Proposed Power Plants in Glades County." (2007) State of Florida. June 5, 2007.

Form FERC-423 Database, Monthly Cost and Quality of Fuels for Electric Plants Data. (2007) Energy Information Administration. April 1, 2009.

Fowler, Mike (2003) "Permit Application No. 2663, Mustang Generating Station, Revised BACT Analysis." Personal Communication. August 29, 2003.

Freund, Paul and John Davison (2002) General Overview of Costs. IPCC Workshop on Carbon Dioxide Capture and Storage. Geneva, Switzerland. April 17-20, 2002.

"The Future of Coal." (2007) Massachusetts Institute of Technology.

"FutureGen - A Sequestration and Hydrogen Research Initiative." (2003) U.S. Department of Energy, Office of Fossil Energy. February 2003.

"Gasification plant bill signed into law." (2008) Wiscasset Newspaper. April 17, 2008.

Glaze, Ben (2008) "Protest sees 13 arrested." South Wales Echo. April 4, 2008.

Goodell, Jeff (2007) "Big Coal's Dirty Move." Rolling Stone. January 12, 2007.

Gore, Albert (2007) Nobel Lecture. Oslo, Norway. December 10, 2007.

"Groups fight power plant permit." (2008) CNN. March 19, 2008.

Hamilton, Michael and Howard Herzog (2008) "Cost Update for The Future of Coal." Internal Report, Massachusetts Institute of Technology. August 14, 2008.

Hanna, John (2008) "New bill on coal-fired plants emerges in Kansas House." The Kansas City Star. March 24, 2008.

Hebert, H. Josef (2008) "Coal plants jeopardized over climate." USA Today. November 14, 2008.

Helms, Kathy and Dine Bureau (2009) "EPA withdraws portion of Desert Rock permit." Gallup Independent. January 26, 2009.

Herszenhorn, David M. (2008) "After Verbal Fire, Senate Effectively Kills Climate Change Bill." The New York Times. June 7, 2008.

Hildebrand, A.N. and H.J. Herzog (2008) Optimization of Carbon Capture Percentage for Technical and Economic Impact of Near-Term CCS Implementation at Coal-Fired Power Plants. 9th International Conference on Greenhouse Gas Technologies. Washington, DC. November 18, 2008.

Holbrook, David (2009) "RE: Selexol for CO2 Capture." Personal Communication. February 16, 2009.

Holt, Neville A. H. (2001) Integrated Gasification Combined Cycle Power Plants. Encyclopedia of Physical Science and Technology.

Hoppock, Dave, Patrick Bean, et al. (2009) "The Influence of Technology and a Carbon Cap on Natural Gas Markets." Duke University, Climate Change Policy Partnership. March 2009.

Horazak, Dennis and Robert Shannon (2009) Personal Communication. March 10, 2009.

Hunt, Spencer (2008) "Energy companies plug coal's 'clean' benefits." The Columbus Dispatch. March 31, 2008.

"IGCC Engineering and Permitting Issues Summaries." (2006) Energy Center of Wisconsin, Clean Coal Study Group. April 2006.

"IGCC stumbles and falls in the US. The spate of cancellations is becoming a flood." (2007) Modern Power Systems. November 26, 2007.

"IPCC Special Report on Carbon Dioxide Capture and Storage." (2005) Intergovernmental Panel on Climate Change, Working Group III.

"JEA kills plans for Taylor County power plant." (2007) Jacksonville Business Journal. July 3, 2007.

Jha, Alok and Terry Macalister (2008) "CO2 plan threatens new coal power plant." The Guardian. June 13, 2008.

Johnson, Keith (2008) "Bank of America: More Heat on Coal." The Wall Street Journal. April 2, 2008.

Jowit, Juliette (2008) "Dirty coal power hit by Euro vote." The Guardian. October 7, 2008.

Joyce, Christopher (2007) "American 'Coal Rush' Hits Some Hurdles." National Public Radio. January 17, 2007.

"Kansas Stands Up Against Coal Pollution" (Advertisement). (2007) The Wichita Eagle, Know Your Power Kansas. October 24, 2007.

"KDHE Denies Sunflower Electric Air Quality Permit." (2007) Kansas Department of Health and Environment. October 18, 2007.

Klein, Alex (2007) "TECO, Nuon Cancellations Underscore IGCC's Woes." Emerging Energy Research. October 5, 2007.

"Know Your Power to Know the Truth" (Advertisement). (2007) The Wichita Eagle, Know Your Power Kansas. November 11, 2007.

Kosich, Dorothy (2008) "Sierra Club says it will sue to stop coal-fired power plant projects." MineWeb Newsletter. May 8, 2008.

"Lawrence legislator angers many with his proposed energy bill." (2009) Lawrence Journal-World. January 26, 2009.

Lefler, Dion (2007) "Anti-coal campaign irritates legislators." The Wichita Eagle. October 28, 2007.

Lefler, Dion (2007) "Coal backers defend their ad's claims." The Wichita Eagle. November 6, 2007.

Ling, Katherine (2008) "FutureGen showdown featured in Senate hearing." Environment & Energy Daily. May 5, 2008.

"Loans program for coal plants suspended." (2008) AFX News Limited. March 5, 2008.

LoBianco, Tom (2009) "Energy pick Chu backs 'clean coal'." The Washington Times. January 14, 2009.

Loder, Asjylyn (2008) "Nuke plant price triples." St. Petersburg Times. March 11, 2008.

Loftis, Randy Lee (2006) "Coming Sunday: Fight looms over Texas air pollution regulations." The Dallas Morning News. November 10, 2006.

Low Carbon Economy Act of 2007. (2007) S. 1766, United States Senate. Version July 11, 2007.

"MacDonald carbon emissions bill receives unanimous support." (2008) Boothbay Register. March 13, 2008.

Massachusetts et al. v. Environmental Protection Agency et al. (2007) Supreme Court of the United States. Decided April 2, 2007.

Matlock, Staci (2007) "2007 Legislature: Opposition to Power Plant Builds Steam." The New Mexican. January 28, 2007.

McElligott, Suzanne (2007) "Sierra Club Pushes IGCC as BACT in Kentucky." August 22, 2007.

Moratorium on Uncontrolled Power Plants Act of 2008. (2008) H.R. 5575, United States House of Representatives. Version March 11, 2008.

Morris, Stephen and Melvin Neufeld (2007) "Plant decision wrong." The Wichita Eagle. November 4, 2007.

"Mr. Rogers Responds: Duke Energy CEO responds to climate scientist Jim Hansen." (2008) Grist. April 2, 2008.

Mufson, Steven (2007) "Power Plant Rejected Over Carbon Dioxide For First Time." Washington Post. October 19, 2007.

Mufson, Steven (2008) "Coal Industry Plugs Into the Campaign." Washington Post. January 18, 2008.

Nace, Ted (2008) "Trends in Coal Plants." Personal Communication. July 8, 2008.

"New Multi-Industry Coalition Aligns to Advocate Energy Security and Environmental Stewardship." (2008) BusinessWire. April 17, 2008.

"NRG in pact for 800 MW coal-fired power plant." (2008) Power Engineering. August 4, 2008.

O'Grady, Eileen (2007) "Kentucky advanced-coal projects obtains air permit." Reuters. November 30, 2007.

O'Grady, Eileen (2008) "Georgia court cites carbon in coal-plant ruling." Reuters. June 30, 2008.

"Overview of RGGI CO2 Budget Trading Program." (2007) Regional Greenhouse Gas Initiative. October 2007.

"PacifiCorp cancels Wyo. coal projects." (2007) Wyoming Tribune Eagle. December 11, 2007.

Page, Stephen D. (2005) "Best Available Control Technology Requirements for Proposed Coal-Fired Power Plant Projects." Personal Communication. December 13, 2005.

Power, Stephen (2008) "Kansan Stokes Energy Squabble With Coal Ruling." The Wall Street Journal. March 19, 2008.

Proctor, Cathy (2007) "Xcel delays IGCC power plant." Denver Business Journal. October 30, 2007.

Raghaven, Sreekumar (2008) "Why is Tata Power silent on Mundra power plant?" International Business Times. April 8, 2008.

Rees, Martin (2008) "Letter to Secretary of State, Department for Business, Enterprise & Regulatory Reform." Personal Communication. April 1, 2008.

"Regional Greenhouse Gas Initiative." (2009) Regional Greenhouse Gas Initiative. Retrieved January 21, 2009, from <http://www.rggi.org/home>.

"Regional Initiatives." (2009) The Pew Center on Global Climate Change. Retrieved January 20, 2009, from http://www.pewclimate.org/what_s_being_done/in_the_states/regional_initiatives.cfm.

Roberts, C. A., J. R. Gibbons, et al. (2004) Potential for Improvement In Power Generation with Post-Combustion Capture of CO₂. 7th International Conference on Greenhouse Gas Control Technologies. Vancouver, BC. September 5-9, 2004.

Robinson, David (2008) "Huntley dream was just too speculative." Buffalo News. July 20, 2008.

Robinson, David (2008) "State Scrubs Clean Coal Power Plant; Huntley Project Too Costly; Plans for Sequestering Carbon Dioxide Doubted." Buffalo News. July 17, 2008.

Robinson, Erik (2007) "Power plant plan to drop new coal technology." Spokesman Review. December 23, 2007.

"SCC says no to new APCO power plant and rate hike." (2008) WSLs. April 14, 2008.

Schoff, Ron (2008) Personal Communication. October 8, 2008.

Schrag, Duane (2008) "Coal plant's bioreactor would start small." Salina Journal. February 22, 2008.

Sebelius, Kathleen (2007) "Permit denial was correct decision." The Wichita Eagle. October 28, 2007.

Shuster, Erik (2008) "Tracking New Coal-Fired Power Plants." National Energy Technology Laboratory. June 30, 2008.

Smith, Rebecca (2008) "Banks Hope to Expand Carbon Rules to Public Utilities." The Wall Street Journal. March 20, 2008.

Souder, Elizabeth (2007) "TXU to take buyout." The Dallas Morning News. February 26, 2007.

Souder, Elizabeth (2009) "Texas Legislature to revive clean coal debate." The Dallas Morning News. January 12, 2009.

"State agency blocks coal power plant." (2007) Minnesota Center for Environmental Advocacy. August 3, 2007.

"States, Provinces Taking Action to Curb Climate Change." (2008) Western Climate Initiative. May 15, 2008.

"Stopping the Coal Rush." (2008) Sierra Club. Retrieved August 28, 2008, from <http://www.sierraclub.org/environmentallaw/coal/plantlist.asp>.

Strangmeier, Suzanna (2005) "TXU adding to coal fleet, expand beyond Texas." Natural Gas Week. November 14, 2005.

Talley, Ian (2009) "EPA Set to Move Toward Carbon-Dioxide Regulation." The Wall Street Journal. February 23, 2009.

"Tampa Electric Cancels Plans for New Coal Plant in Florida." (2007) EnergyOnline News. October 5, 2007.

"Taylor Energy Center to Suspend Plant Permitting and Participate in State Dialogue on Florida's Energy Future." (2007) City of Tallahassee. July 3, 2007.

"Technologies to Reduce or Capture and Store Carbon Dioxide Emissions." (2007) The National Coal Council. June 2007.

"Three Strikes Against Kansas Coal Plants: Sebelius Vetoes Again." (2008) Environment News Service. May 16, 2008.

"Tracking New Coal-Fired Power Plants." (2007) National Energy Technology Center. May 1, 2007.

"U.S. Coal Exports." (2008) Energy Information Administration. Retrieved February 26, 2009.

"U.S. Coal Imports." (2008) Energy Information Administration. Retrieved February 26, 2009.

U.S. Natural Gas Imports and Exports. (2008) Energy Information Administration. December 24, 2008.

"U.S. Natural Gas Imports by Country." (2009) Energy Information Administration. Retrieved February 26, 2009.

"The Urgency of Sustainable Coal." (2008) The National Coal Council. May 2008.

Wald, Matthew L. (2008) "Georgia Judge Cites Carbon Dioxide in Denying Coal Plant Permit." The New York Times. July 1, 2008.

Wald, Matthew L. (2008) "Mounting Costs Slow the Push for Clean Coal." The New York Times. May 30, 2008.

Wald, Matthew L. and Felicity Barringer (2008) "E.P.A. Ruling Could Speed Up Approval of Coal Plants." The New York Times. December 19, 2008.

Wallace, Daniel (2007) "Russell Station plans change." Rochester Democrat and Chronicle. September 29, 2007.

Walsh, Bryan (2008) Environmentalists Win Big EPA Ruling. Time. November 13, 2008.

Weiss, Daniel J., Nick Kong, et al. (2008) "The Clean Coal Smoke Screen." Center for American Progress. December 22, 2008.

Weiss, Mitch (2008) "Environmentalists try to stop NC coal-fired plant." Forbes.com. November 18, 2008.

"The Western Climate Initiative." (2008) The Western Climate Initiative. Retrieved August 21, 2008, from <http://www.westernclimateinitiative.org/>.

Wetzel, Dale (2008) "Coal company suspends efforts to build N.D. power plant." The Bismarck Tribune. May 21, 2008.

Whitten, Daniel (2009) "Clean-Coal Debate Pits Al Gore's Group Against Obama, Peabody." Bloomberg. February 4, 2009.

"Why are these men smiling?" (Advertisement). (2007) The Wichita Eagle, Kansans for Affordable Power. November 6, 2007.

Wise, Marshall A., James J. Dooley, et al. (2007) "Modelling the impacts of climate policy on the deployment of carbon dioxide capture and geologic storage across electric power regions in the United States." International Journal of Greenhouse Gas Control 1(2): 261-270.

Wroughton, Lesley (2008) "Green groups oppose World Bank's India coal plant." Reuters. April 7, 2008.

Wynn, Gerard and Jacqueline Cowhig (2008) "Coal's future is safe - but what about the climate?" Reuters. August 5, 2008.

APPENDICES

APPENDIX A: DETAILS OF SC PC AND IGCC MODELS

Example of Supercritical Model

INPUTS		Second train CDR	45.02%	Study Capture: 65%		
OUTPUTS to other sheets		Second train compressor	45.02%			
		Case 11 Non	Case 12 Cap	Study Case	Conversions	
Capture level	percent	0%	90.033%	65%	input	
Capacity Factor	percent	85%	85%	85%		
Operating Hours per year	hours	7446	7446	7446		
Coal feed rate	lb/hr	411259	586677	411259	input	
Heat input from coal	Btu/hr	4797747494	6844173882	4797747494	11666	Btu/lb coal
CO2 cap and seq	lb/h	0	1252540	634021	math	
CO2 cap and seq	ton/h	0	626	317	math	
Steam rate to turbine	lb/hr	3664793	5241041	3664793	8.911	lb steam / lb coal
Regen heat needed	MMBTU/h	0	1916	970	1530	<-- input on Results Table sheet, Btu/lbCO2
Regen steam needed	lb/h	0	1395004	706134	1373.8	Btu / lb steam
Regen heat extracted from turbine	MMBTU/h	0	2495	1263		
Steam extracted from turbine	lb/hr	0	1815947	919211	1.30175	steam extracted / steam needed
Steam remaining after extraction	lb/hr	3664793	3425094	2745582	math	
Condenser outlet	lb/h	2772326	2238986	1898708	$0.756475 * \text{steam}_{\text{turb}} - 1.3779 * \text{co2cap}$	
Flue gas flowrate from FGD	lb/h	4787582	6833096	4787582	11.641	lb gas / lb coal
Gas to CO2 compressor: mole fraction CO2	%	0	0.9862	0.9862		
Gas to CO2 compressor	lb/h	0	1259707	637651	0.99431	mass % CO2 (converted from mole frac)
CO2 emissions	lb/h	975417	138660	341396	math	
CO2 generated	lb/h	975417	1391200	975417	2.3718	lb CO2 / lb coal
Gross output / steam input for capture level	kW/lb steam	0.15833	0.126586	0.135414	linear interp, implicitly accounts for turbine efficiency	
CRU trains	number	0	2	2	dependent on capture level	
Compressor trains	number	0	2	2	dependent on capture level	
CRU capacity (total)	lb/h flue gas	0	7516000	3801866	1.099940642	=that excess ratio*fluegas*scale for capture
CRU capacity (each)	lb/h flue gas	0	3758000	1900933	math	
compressor capacity (total)	lb/h	0	1377680	697367	1.0937	excess ratio capacity: gas to compressor
Compressor capacity (each)	lb/h	0	688840	348684	math	

Condenser duty capacity	MMBtu/h	2410	1970	2187	0.0002423	MMBtu/h saved per lb steam extracted
Turbine capacity	MW	610	700	523	0.00105	average excess capacity
Cooling tower capacity	MMBtu/h	2520	5610	2864		based on linear interp of (pump cap / tower cap)
Circulating water pumps capacity (each)	gpm	126000	162000	99514		math
Circulating water pumps capacity (operating)	gpm	252000	648000	398057		=0.6127*coal+0.2304*co2ccs
Circulating water pumps number operating	number	2	4	4		dependent on capture level
Circulating water pumps number spare	number	1	2	2		"
Circulating water pumps number total	number	3	6	6		"
Steam T&G and Access	1000\$	66,606.0	73,471.0	59658	0.71280	capacity exponent
CO2 Removal System (each)	1000\$	-	205,421.5	140204	0.56044	capacity exponent
CO2 Compressor (each)	1000\$	-	23,181.5	15614	0.58047	capacity exponent
Circulating Water Pumps (each)	1000\$	746.3	838.5	669	0.46351	capacity exponent
Cooling Tower	1000\$	13,695.0	23982	14977	0.70009	capacity exponent
Condenser	1000\$	10,370.0	9,057.0	9716	0.67155	capacity exponent
gross turbine/generator output	kW	580,260	663,445	496263		math
aux power to stripper/regen	kW	-	21,320	10792	0.0170214	kWe / lb CO2
aux power to compressor	kW	-	46,900	23740	0.0374439	kWe / lb CO2
aux circulating water pumps	kW	4,700	12,260	7531	0.01892	kWe / gpm total operating CW capacity
aux cooling tower fans	kW	2,460	6,340	3895	0.0098	kWe / gpm CW capacity
aux transformer loss	kW	1,830	2,300	1677		linear interp on basis of percent of gross
aux condensate pumps	kW	790	630	534	0.000281	MWe/(lb/h condensate)
Water consumption	1000gal/day	3,918	8,755	5520		0.009526(water/coal)*coal+0.002528(water/co2)*co2
MEA Solvent	ton/day	-	1.51	0.764	0.0000012	(1000gal/day water) / (CO2capseq)
NaOH	ton/day	-	7.36	3.726	5.87606E-06	(ton/day solv) / (CO2capseq)
H2SO4	ton/day	-	7.18	3.634	5.73235E-06	(ton/day H2SO4) / (CO2capseq)
Limestone	ton/day	490	697.00	489	0.0011901	(ton/day Limestone) / (lb/h coal)
Activated carbon	lb/day	-	1,800.00	911	0.00144	(lb/day actC) / (CO2capseq)
Ammonia NH3	ton/day	74	116.00	75.7	0.000184	(ton/day Ammonia) / (lb/h coal)

Example of IGCC Model

No Shift, max capture 28.722% determined by model, from Result Table sheet

Single Shift, max capture 78% <--input on Result Table sheet

Second train CO2 compressors 45.10% <--input on Result Table sheet

		Study capture			
		Case 1	Case 2	65.0%	
		Non	Cap	Study	input
Capture	percent	0	90.20%	65.00%	
air to ASU	lb/h	1539145	1855925	1855925	from PFD
vent gas from ASU	lb/h	371000	229617	229617	from PFD
claus plant oxidant	lb/h	8942	6904	6904	from PFD
gasifier oxidant	lb/h	409853	418847	418847	from PFD
coal*	lb/h	489634	500379	500379	from PFD
heat input from coal	Btu/h	5,712,070,244	5,837,421,414	5,837,421,414	*11666 Btu/lb coal
h20 for slurry	lb/h	201142	205556	205556	from PFD
slag	lb/h	53746	54925	54925	from PFD
from quench	lb/h	1324300	1343898	1343898	from PFD
from quench molar	lbmol/h	60278	67674	67674	from stream table
CO mole fraction	mole frac	0.2922	0.2666	0.2666	from stream table
CO molar flow rate	lbmol/h	17613	18042	18042	=mole frac * molar flow
CO2 mole frac	percent	12.76%	11.66%	12%	from stream table
CO2 molar flow rate	lbmol/h	7691	7891	7891	from stream table
H20 mole fraction	mole frac	0.2726	0.337	0.3365	from stream table
H20 molar flow rate	lbmol/h	16432	22772	22772	=mole frac * molar flow
H20:CO mole ratio	ratio	0.9329	1.2622	1.2622	division
H2 mole frac	percent	28.49%	26%	26%	from stream table
H2 molar flow rate	lbmol/h	17173	17555	17555	=mole frac * molar flow
N2 mole frac	percent	0.76%	0.69%	0.69%	from stream table
N2 molar flow rate	lbmol/h	448.9	467	467	=mole frac * molar flow
CH4 mole frac	percent	0.08%	0.06%	0.06%	from stream table
CH4 molar flow rate	lbmol/h	48.2	40.6	40.6044	=mole frac * molar flow
Ar mole frac	percent	0.67%	0.51%	0.51%	from stream table
Ar molar flow rate	lbmol/h	403.9	345.1	345.1374	=mole frac * molar flow

shift stages	number	0	2	1	dep on capture level
shift trains	number	0	2	2	dep on capture level
shift conversion needed	percent	0	96%	55.24%	
CO to convert	lbmol/h	0	17320	9967	gives max 96%conv*COflow, or (%cap*CO2generatedmolar / (eff of AGR)-CO2already), or zero
shift steam added	lbmol/h	0	13313	0	(2:1ratio)*COtoconvert-H2Oinstream, 0 if goes negative
shift steam added	lb/h	0	239846	0	lbmole to lbmass
shift steam added gpm	gpm	0	175454	0	0.7315289
H2O:CO to target for convert	ratio	0	2.0001	2.1934	
flow to shift	lb/h	0	1583744	1343898	sum
flow to COS hydrolyzer	lb/h	1324300	0	0	sum
to cooling and KO	lb/h	1206757	1583744	1343898	flow to shift or COS-h
water to cooling and KO (minus shifted)	lb/h	295772	337771	230496	
percent lost	percent	102.22%	100.86%	100.86%	case 2 value if shift, otherwise case 1 value
cooled & KO losses	lb/h	302347	340670	232475	percent lost * to cooling and KO flow
CO2 molar flowrate	lbmol/h	7758	25201	17858	increase by CO converted
CO molar flowrate	lbmol/h	17399.13	726.7	8075	decrease by CO converted
H2 molar flowrate	lbmol/h	17150.7	34842	27522	increase by CO converted
N2 molar flowrate	lbmol/h	448.9	467	467	same
to AGR	lb/h	904410	1243074	1111423	=to coolingKO-KO water
AGR stages	number	1	2	2	assume always need two
CO2 flowrate	lb/h	341430	1109096	785919	lbmole to lbmass
entering CO2 mass frac	percent	37.8%	89.22%	70.71%	co2 rate / AGR rate
AGR percent CO2 cap	percent	4.2%	93.2%	95.0%	BUT can accomplish 95%
N2 gained in AGR as % of N2 in feed	percent	40.2%	25.3%	25.3%	ASSUME will always be as case 2 since always using two-stage AGR
total N2 molar flow		629.49	582.53	584.996	=flow*(1+%gained)
AGR N2 split: to turb/in feed		99.7%	110.0%	110.0%	ASSUME will always be as case 2 since always using two-stage AGR
CO2 captured (or sent to claus)	lb/h	14,444	1,033,927	746,623	=AGR percent cap * co2 flowrate
CO2 captured molar	lbmol/h	328	23493	16965	
capture rate these numbers	percent	1.3%	90.0%	65.000%	
CO2 generated	lb/h	1138385	1148651	1148651	2.296
CO2 generated molar	lb/mol/h	25866	26100	26100	
CO2 emitted	lb/h	1,123,941	114,724	402,028	=generated - captured
CO2 emission rate	lb/MWh gross	1459	154	532	
CO2 emission rate net	lb/MWh net	1775	206	693	=above*gross/net

co2 from AGR	lb/h	0	1033927	746623	equals co2 captured
CO2 to turbine	lbmol/h	7951	1717	893	previous flow - captured
CO to turbine	lbmol/h	17399	728	8075	same
H2 to turbine	lbmol/h	17161	34855	27522	same
N2 to turbine	lbmol/h	1605	514	514	=N2 split turb/feed * feed
Total fuel to turbine	lbmol/h	44115	37814	37003	
CO2 to turbine	lb/h	349906	75565	39296	
CO to turbine	lb/h	487350	20391	226179	
H2 to turbine	lb/h	34596	70268	55484	
N2 to turbine	lb/h	44943	14397	14384	
Total fuel to turbine	lb/h	916795	180621	335343	
Residuals in flow to turbine	lb/h	19175	18359	18359	always same: Ar and Ch4
Syngas to syngas expander	lb/h	795458	198980	353701	
Syngas bypassed to compressor	lb/h	140512	0	0	always zero. Boost compressor used for non-capture case but is mostly CO2 and N2 from the AGR
syngas to combustor	lb/h	935,970	198,980	353,701	
syngas enthalpy	Btu/lb	131.19	481	251.3	equation from file "master enthalpy density data", based on %CO conversion
syngas bypass enthalpy	Btu/lb	27.1	0	0	never use bypass
syngas density	lb/ft3	0.998	0.263	0.496	equation from file "master enthalpy density data", based on %CO conversion
syngas bypass density	lb/ft3	2.481	0.000	0.000	always zero: no bypass
syngas volumetric flow	ft3/hr	853,687	756,578	712,929	=flow*density bypassed + flow*density expanded
syngas heat flow	Btu/lh	108,164,010	95,621,829	88,892,415	=flow*enthalpy bypassed + flow*enthalpy expanded
nitrogen diluent	lb/h	1,035,409	1,200,557	1,266,039	=200000000Btu/hr - heat flow from above
nitrogen density	lb/ft3	1.424	1.424	1.424	always same
nitrogen enthalpy	Btu/lb	87.76	87.76	87.76	always same
nitrogen heat flow	Btu/h	90867494	105360882	111107585	
nitrogen volumetric flow	ft3/hr	727113	843088	889072	
total volumetric flow	ft3/hr	1580800	1599666	1602001	
total heat flow	Btu/hr	199,031,504	200,982,711	200,000,000	
actual heat content	Btu/ft3	128.33	125.64	124.84	need to maintain 120-128 BTU/scf. All values do fall in this range.
heatflow in terms of electricity	kW	58,299	58,870	58,582	
total mass flow to combustor	lb/h	1971379	1399537	1619740	

Gas Turbine Power	464.3	464.01	462	2.309E-06 MWe / lb total heatflow above
Sweet Gas Expander Power	7.13	6.26	6.70	7.28646759 conversion max based on nocap case, power/coal feed * coalfeedstudycase, then linearly interpolated WRT CO
Steam Turbine Power	298.92	274.69	287.76	305.479788 conversion max based on nocap case, power/coal feed * coalfeedstudycase, then linearly interpolated WRT CO
TOTAL GROSS POWER, MWe	770.35	744.96	756.20	
capacity factor	80%	80%	80%	
operating hours	7008	7008	7008	
5A.4 COS-H Reactors (case 1)	664000	0	0	1.003 excess: capacity / flow TWO TRAINS
# per train	1	0	0	
5A.4 Shift Reactors (case 2)	0	871000	739094	1.100 excess: capacity / flow TWO TRAINS
# per train	0	2	1	
5A.1 Single/Double Stage Selexol	497000	684000	610760	1.099 excess: capacity / flow TWO TRAINS
# per train	1	1	1	
5B.2 CO2 Compression & Drying	0	40859	29505	0.08 = scfm capacity total / co2 captured
# per train	0	2	2	
actual trains	0	2	2	
6.1 Combustion Turbine Generator	232	232	231	0.99997845 always 2, gas turb power from above * excess cap
# per train	1	1	1	
6.2 Syngas Expander	437500	109440	194534	1.100 linearly interpolated excess ratio 1.1000 1.1000
# per train	1	1	1	
5A.4 COS-H Reactors	\$ 7,633,000	\$ -	\$ -	0.7 capacity exponent \$/cap
5A.1 always Double Stage Selexol	\$ 80,767,000	\$ 171,950,000	\$ 158,844,513	0.7 capacity exponent \$/cap
5A.4 Shift Reactors	\$ 15,196,000	\$ 8,338,448	\$ 8,338,448	0.7 capacity exponent \$/cap
5B.2 CO2 Compression & Drying	0	\$ 18,786,000	\$ 14,957,616	0.7 capacity exponent \$/cap
5B.2 CO2 Compression & Drying	\$ -	\$ 37,572,000	\$ 29,915,232	
6.1 Combustion Turbine Generator	\$ 109,578,000	\$ 122,580,000	\$ 122,160,141	0.7 capacity exponent \$/cap
6.2 Syngas Expander	\$ 7,803,000	\$ 7,560,000	\$ 7,659,942	0.023 capacity exponent \$/cap
CO2 Compressor	0	27400	19786	0.0265009 kW/lb CO2
Selexol Unit Auxiliaries	3420	17320	11450	=0.00698*coalfeedcase+(%capcase/%case2*13827.35)

Example of Cost of Electricity Calculation

		Base	Study		Low Risk
	Net Output	550150.0	427833.3 kW		
	Capacity Factor	85%	85%		
				Capital Charge Factor	0.164 CCF
				Coal Levelization Factor	1.2089 CLF
				O&M Levelization Factor	1.1618 OMF
Capital	Total plant cost	\$ 866,392,000	\$ 1,173,486,740		
	TPC \$/kW	\$ 1,575	\$ 2,743		
	COE capital	3.47	6.04 cents/kWh	=TPC*100*CCF/7446hrs	
Fuel	Fuel Price	1.8049	1.8049 \$/MMBtu		
	Heat Input from Coal	4797747494	4797747494 Btu/hr		
	Fuel Cost	8,659	8,659 \$/hr		
	Fuel Cost	0.02	0.02 \$/kWh		
	COE fuel	1.90	2.45 cents/kWh	=fuel price*heatinput*100*CLF/(10^6*netoutput)	
O&M	Fixed O&M	25.175	25.175 \$/kW		
	Fixed O&M	0.003	0.003 \$/kWh		
	COE fixed	0.39	0.39 cents/kWh	=\$/kWh O&M * 100*OMF	
	Variable O&M Annual	\$ 19,937,371.34	\$ 21,927,023.56		
	Variable O&M	0.00487	0.00688 \$/kWh		
	COE variable	\$ 0.5655	0.7997 cents/kWh	=\$/kWh O&M * 100*OMF	
	COE Total O&M	0.96	1.19 cents/kWh		
Total	Total COE	6.33	9.68 cents/kWh		

Example of Cost of Mitigation Calculation

	Base	Study
Emissions	1773	798.0 lbs/MWh net
Emissions	0.00089	0.00040 tons/kWh net
Delta Emissions		0.00049 tons/kWh net
CO2 Produced	0.00089	0.00114 tons/kWh net

TPC CO2 Avoided	52.770 \$/ton	$=(\text{componentCOEstudy}-\text{componentCOEbase})/(\text{delta emissions}*100)$
Fuel CO2 Avoided	11.16 \$/ton	$=(\text{componentCOEstudy}-\text{componentCOEbase})/(\text{delta emissions}*100)$
O&M CO2 Avoided	4.80 \$/ton	$=(\text{componentCOEstudy}-\text{componentCOEbase})/(\text{delta emissions}*100)$
CO2 Avoided Total	68.73 \$/ton	=Sum

TPC CO2 Captured	34.720 \$/ton	$=(\text{componentCOEstudy}-\text{componentCOEbase})/((\text{CO2 produced} - \text{CO2 emissions})*100)$
Fuel CO2 Captured	7.34 \$/ton	$=(\text{componentCOEstudy}-\text{componentCOEbase})/((\text{CO2 produced} - \text{CO2 emissions})*100)$
O&M CO2 Captured	3.16 \$/ton	$=(\text{componentCOEstudy}-\text{componentCOEbase})/((\text{CO2 produced} - \text{CO2 emissions})*100)$
CO2 Captured Total	45.22 \$/ton	=Sum